

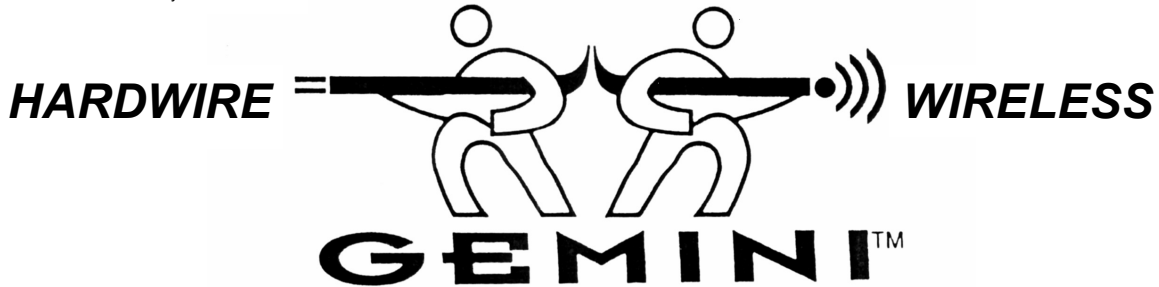

Publicly traded on NASDAQ Symbol: NSSC

PROGRAMMING INSTRUCTIONS



GEM-P816 CONTROL PANEL/COMMUNICATOR

Programming the GEM-P816 Control Panel with the "Classic" GEM-RP1CAe2 Keypad and the "K Series" GEM-K1CA Keypad

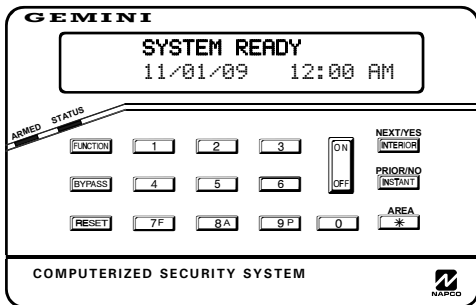

"Classic" GEM-RP1CAe2

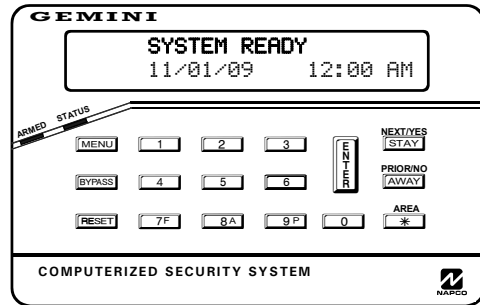

"K Series" GEM-K1CA

Quick Start (for "Classic" GEM-RP1CAe2)

1. Refer to the wiring diagram, connect Siren, Aux. Power, PGM Output, Remote Bus, Earth ground, Zone and Telephone wiring. NOTE: See Installation Instructions (WI994).
2. Connect AC power first and then the battery.
3. Configure the keypad (see page 42).
4. Access the Easy Menu Driven (Dealer Program) Mode:

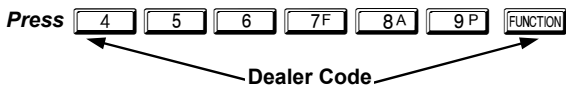

Press NO (**INSTANT**) until "ACTIVATE PROGRAM Y/N" appears on the keypad display.

Press YES (**INTERIOR**) to Enter Dealer Program Mode. Go to page 5.

Quick Start (for "K-Series" GEM-K1CA)

1. Refer to the wiring diagram, connect Siren, Aux. Power, PGM Output, Remote Bus, Earth ground, Zone and Telephone wiring. NOTE: See Installation Instructions (WI994).
2. Connect AC power first and then the battery.
3. Configure the keypad (see page 42).
4. Access the Easy Menu Driven (Dealer Program) Mode:

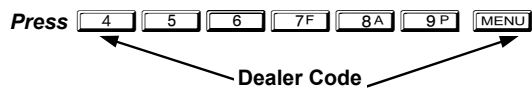

Press NO (**AWAY**) until "ACTIVATE PROGRAM Y/N" appears on the keypad display.

Press YES (**STAY**) to Enter Dealer Program Mode. Go to page 5.

**THIS MANUAL INCLUDES FEATURES WHICH ARE ONLY AVAILABLE IN
CONTROL PANEL FIRMWARE VERSION 30G OR LATER.**

CHANGES FROM PREVIOUS EDITION

The following changes have been made to this manual (WI995E) since the previous edition (WI995D):

- All "Not for UL installations" footnote references have been made changed to a consistent "double dagger" symbol ("‡").
- Warning added to page 2 (see below).







Warning: The use of non-NAPCO wireless devices with this control panel has not been evaluated by UL and voids the UL listing. In addition, the performance of these devices can not be guaranteed as compatible with NAPCO control panels.

IMPORTANT NOTE

This manual supports the keypad programming of the GEM-P816 control panel with the NAPCO "classic" GEM-RP1CAe2 keypad as well as the GEM-K1CA "K Series" keypad. The new "K Series" GEM-K1CA model offers the new STAY and AWAY buttons with simplified functionality, along with the new MENU and ENTER buttons.

While the instructions in this manual are depicted using the GEM-K1CA keypad, the manual applies to both the "classic" and the "K Series" keypads.

Program Mode is the same for both keypads--**only the button names have changed**, as follows:

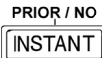
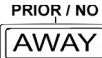
- The  button and the  button operate identically (in Program Mode) for both keypads.
- The  button and the  button operate identically (in Program Mode) for both keypads.
- The  button and the  button operate identically (in Program Mode) for both keypads. The words "NEXT/YES button" are used in this manual.
- The  button and the  button operate identically (in Program Mode) for both keypads. The words "PRIOR/NO button" are used in this manual.

 **For consistency, it is recommended that all keypads either be all "classic" or all "K Series"--both keypad types should not be used in one alarm system.**



NAPCO Security Systems, Inc.
333 Bayview Avenue, Amityville, New York 11701
For Sales and Repairs, call toll free: (800) 645-9445
For direct line to Technical Service, call toll free: (800) 645-9440
Internet: <http://www.napcosecurity.com>

TABLE OF CONTENTS

SYSTEM PROGRAMMING OPTIONS	4	DIRECT ADDRESS PROGRAM MODE	11
INTRODUCTION.....	4	Direct Address Overview	11
DOWNLOADING FROM A COMPUTER	4	Address Mode Displays	11
EASY MENU DRIVEN PROGRAM MODE	5	Binary (Bit) Format Example	11
Dealer Program - Preliminary Information	5	Decimal Format Example	12
Accessing Dealer Program Mode	5	Hexadecimal Format Example.....	13
Customizing a Default Program	5	Programming Conventions Used in this Manual	14
GEM-RP1CAe2/GEM-K1CA Easy Program Menu.....	6	SYSTEM DELAYS & TIMEOUTS	15
Total Number of Zones in Area 1	6	SYSTEM OUTPUT TIMEOUTS	16
Fire Zones in Area 1	6	DOWNLOAD/CALLBACK OPTIONS	16
2-Wire Fire Zones in Area 1	6	PAGER FORMAT OPTIONS.....	16
Local or Central Station Reporting System	6	SYSTEM OPTIONS.....	17, 19
Exit/Entry Zones in Area 1	6	CS RECEIVER OPTIONS	20
Interior Zones in Area 1	6	CS SUBSCRIBER ID OPTIONS	21
24 Hour Zones in Area 1.....	6	CS SYSTEM REPORTING OPTIONS	22
Chime Zones in Area 1	7	CS AREA & SYSTEM REPORTING OPTIONS	22
Chime 2 Zones in Area 1	7	CS ZONE REPORTING OPTIONS.....	23
Exit/Entry2 Zones in Area 1	7	CS USER REPORTING OPTIONS.....	24
50 mS Loop Response Zones.....	7	EZM GROUP OPTIONS	25
Aux Output Activated on Alarm Zones	7	AREA BELL CONTROL OPTIONS	26
Sensor Watch Zones	7	KEYPAD OPTIONS	27
Keypad Sounder On Alarm Zones	7	TEMPERATURE DISPLAY AT KEYPAD	28
Auto Bypass Re-entry Zones	7	ZONE OPTIONS - ZONES 1 TO 16	29
Enable No EOLR Zones	7	RF RECEIVER & SUPERVISORY TIMER OPTIONS	36
Enable Telco Line Fault Test?	7	CLEAR PROGRAM OPTIONS	37
Enable Burg Output Chirp on Keyfob?	8	USER PROGRAM MODE	37
Enable SIA CP-01 Features?.....	8	Preliminary Information	37
Number of Keypads in Area 1	8	Accessing User Program Mode.....	38
Central Station Receiver 1 Telephone Number	8	User Codes.....	38
Central Station Receiver 1 Account Number	8	Zone Descriptions.....	39
Central Station Receiver 1 Format.....	8	Date.....	39
Enter User Codes	8	Time.....	39
RF Transmitter Points	9	KEYPAD CONFIGURATION MODE	40
Keyfob Transmitters as Arm/Disarm & Control		Keypad Installation.....	40
Devices.....	9	Configuring the Keypads.....	40
Keyfob Transmitters as Zone Input Devices	10	EASY MENU PROGRAMMING WORKSHEETS	42
Enter Zone Descriptions	10	ALPHABETICAL INDEX	46
Enter Date	10	ADDRESS NUMBER INDEX	51
Enter Time	10	GEM-P816 WIRING DIAGRAM	56
Dealer Code.....	10		
Test Timer	10		
Clear Dealer Program	10		
Cold Start.....	10		

Refer to accompanying GEM-P816 Installation Instructions (WI994) for installation information.



SYSTEM PROGRAMMING OPTIONS

INTRODUCTION

The GEM-P816 control panel may be programmed by various means, each of which will be covered in detail in the sections that follow. Keypad displays shown are for a GEM-RP1CAe2/K1CA (version 8 keypad), the recommended keypad for programming. For Programming Instructions with the GEM-RP2ASe2/GEM-K2AS, GEM-RP3DGTL/GEM-K3DGTL and the GEM-RP4RFC/GEM-K4RF series, see W11182.

✓ **Downloading From a Computer.** This is the preferred method of programming. The panel may be downloaded from (or uploaded to) an IBM PC-compatible computer, either locally or remotely. Napco's PCD-Windows Quickloader software features context-sensitive help screens as well as an error-checking utility that prevents programming of incompatible or conflicting data to ensure proper panel operation. **Note:** Unattended downloading from a computer is not allowed for Fire Alarm or UL installations.

✓ **Easy Menu-Driven Program (Dealer Program) Mode - Keypad Programming.** The Easy Menu-Driven Program Mode allows keypad programming of number of zones in area 1, number of fire zones (both 4-wire and 2-wire), local or Central Station reporting, number of exit/entry zones, number of interior zones, number of 24 hour zones, number of chime zones, Chime 2 zones, Exit/Entry2 zones, 50ms loop response zones (**Note:** 750mS is required for Loop Response time in UL installations), aux output activated on alarm zones, sensor watch zones, keypad sounder on alarm zones, auto bypass re-entry zones, EOLR zones, number of keypads in area 1, Central Station telephone number, Central Station account number, Central Station receiver format, User Codes, RF transmitter points, RF keyfob transmitters, zone descriptions, date/time, dealer code, Test Timer, Telco line fault test, Burg output chirp on keyfob, keypad time/date display, enable CP-01 programming, and clear dealer program/cold start. For new panels, a custom default program may be created at the keypad. A menu-driven utility prompts the installer to configure the system. Further detailed customization is accomplished in the Direct Address Program Mode.

✓ **Direct Address (Dealer Program) Program Mode - Keypad Programming.** The Direct Address Program Mode is an extension of the Dealer Program Mode wherein data is entered at the keypad by location. This mode is accessed from the Easy Menu Driven Program Mode by pressing the  button at any time.

✓ **User Program Mode - Keypad Programming.** The User Program Mode is intended for authorized users and is limited to keypad programming of User Codes, Time, Date and Zone Descriptions.



DOWNLOADING FROM A COMPUTER

The control-panel program may be downloaded from the computer by any of the following methods.

Local Downloading

(**Note:** This procedure should be used after installation, after peripheral devices are connected).

For direct high-speed data transfer to the control panel from a desktop computer, connect the download jack (JP2) on the panel to the LOCAL jack (J3) on the Napco PCI2000/3000 computer interface using the supplied 6-conductor cable. (Refer to PCI2000/3000 Installation Instructions W1443 for wiring diagram and procedures).

Similarly, a high-speed local download may be made in the field using a notebook or laptop computer. Connect JP2 on the control panel to a Napco PCI-MINI computer interface using the 6-conductor cable supplied. (Refer to PCI-MINI Installation Instructions W1767).

Remote Downloading

(Also see PCI2000/3000 Installation Instructions W1443). **Note:** Unattended downloading from a computer is not allowed for Fire Alarm or UL installations.

Function Mode

Start by establishing a telco connection between the computer operator and the installer. During this procedure, voice contact will be lost, therefore both the installer and the computer operator should be familiar with the operation. When a steady high-pitched tone is heard at the site phone, access the "ACTIVATE DOWNLOAD" Function (see Keypad Programming Modes), then press the  button or the **NEXT/YES** button; the site phone will go dead.















Hang up the phone and wait for a call from the central station confirming a successful download.

Callback Method

An installed, unattended panel may be programmed or reprogrammed remotely using the Callback-Method Download feature of the PCD-Windows software. Remote downloading requires a modem compatible with the PCI2000/3000. Upon answering the call from the computer, the panel will verify the Download Security Code and, if confirmed, will establish a connection. If a Callback Number is programmed into the panel, the panel will automatically disconnect and call the computer at this number before establishing a connection.















EASY MENU DRIVEN PROGRAM MODE

DEALER PROGRAM - PRELIMINARY INFORMATION

-  The Default Dealer Code is      . Use this code to enter the Dealer Program Mode to program a custom Dealer Code, which replaces the Default Dealer Code. If you clear your Dealer Code, use the Default Dealer Code once again to enter programming.
-  After entering codes or data, press the save  button. Data will not be stored into memory unless  is pressed.
-  If the keypad is in the Program Mode and no activity is detected for longer than 4 minutes, a steady tone will sound.
-  Silence the sounder by the  button to continue, or by pressing the  button to exit.
-  When programming a Multiple Area System, Direct Address Programming Mode must be used to complete the program.



For ease of programming, it is recommended that a GEM-RP1CAe2 or GEM-K1CA be used. If a GEM-RP2ASe2/ GEM-K2AS is used, see W11182.

ACCESSING DEALER PROGRAM MODE

1. Press        Dealer Code (Default =       )

2. Press **PRIOR/NO** button until "ACTIVATE PROGRAM Y/N" appears on LCD screen.

3. Press **NEXT/YES** button to Enter Dealer Program Mode.



4. Press   to Exit Dealer Program Mode when finished.

CUSTOMIZING A DEFAULT PROGRAM

For new panels, you can design a default program that will best suit your application. Using this procedure, you will configure the panel for:

- Number of Zones in Area 1
- Fire Zones in Area 1
- 2-Wire Fire Zones in Area 1
- Local or Central Station Reporting System
- Exit/Entry Zones in Area 1
- Interior Zones in Area 1
- 24 Hour Zones in Area 1
- Chime Zones in Area 1
- Chime 2 Zones in Area 1
- Exit/Entry2 Zones in Area 1
- 50mS Loop Response Zones (Note: 750mS is required for Loop Response time in UL installations).
- Aux Output Activated on Alarm Zones
- Sensor Watch Zones
- Keypad Sounder on Alarm Zones
- Auto Bypass re-entry Zones
- Enable no EOLR Zones
- Enable Telco Line Fault Test
- Enable Burg Output Chirp on Keyfob
- Enable CP-01 Programming
- Number of Keypads in Area 1
- Central Station Receiver 1 Tel. Number
- Central Station Receiver 1 Account Number
- Central Station Receiver 1 Format
- Enter User Codes
- RF Transmitter Points
 - Quick "Enroll" Method
- Keyfob Transmitters
- Enter Zone Descriptions
- Enter Date
- Enter Time
- Dealer Code
- Test Timer

This procedure will automatically set up system keypads, EZMs, wireless transmitters, etc. After your basic default program has been loaded, you may alter it as necessary in the Direct Address Program Mode.

NEW PANELS: The custom default program may be created for new panels only. Once the panel has been programmed by any means, the number zones will be suppressed and cannot be changed. Should it be necessary to create a new custom default program, (a) from the Dealer Program Mode, press the  button to enter the Direct Address Program Mode; (b) access Location 2285 (Clear Program); (c) press the  button and start over.



GEM-RP1CAe2/GEM-K1CA Keypad Easy Program Menu

To create a custom program using the GEM-RP1CAe2/GEM-K1CA keypad, simply answer the following questions and record your information on the *Easy Menu Programming Worksheet*. In each of the following steps, press **[MENU]** to set cursor, the NEXT/YES button to go forwards, the PRIOR/NO button to go backwards, **[SAVE]** to save and **[RESET]** twice to exit at any time.

```
#of Zns in Area1
Enter # Zones XX
```

(Direct Entry)

Total Number of Zones in Area 1 (New Program Only)

- Enter the total number of zones to be programmed for Area 1.
- Valid entries are from 01 to 16. Directly enter the total number of zones, including leading zeros.
- The system is based on groups of 4 zones each (after the first 8 zones), and will automatically round up to the next group of 4. For example, if you enter 18, it will automatically convert this to 20 zones. Press **[SAVE]** to save. Press the NEXT/YES button to proceed.

```
Fire Zones
Enter Zone # **
```

(Direct Entry)

Fire Zones in Area 1 (New Program Only)

- Enter the zone number of any Fire Zones (including 2-wire, 4-wire or wireless).
- Valid entries are from 01 to 16.
- Directly enter each zone number, including leading zeros, and press **[SAVE]** to save, and then repeat for any additional zone(s). Press the NEXT/YES button to proceed.

```
2-Wire Fire Zns
Enter Zone # **
```

(Direct Entry)

2-Wire Fire Zones in Area 1 (New Program Only)

- Enter the zone number of any Fire Zone (from previous question) to be used with 2-wire smoke detectors.
- Valid entries are 07 and 08. Directly enter each zone number, including leading zeros.
- Press **[SAVE]** to save, and repeat for any additional zone(s); press NEXT/YES to proceed.

NOTE: Only zones which have been designated as Fire Zones can be programmed as 2 Wire Fire zones. JP3 must be set to "2-WF" position for 2-wire fire. (refer to Installation Instructions).

```
Report All Zones
To Central? Y/N
```

(Press YES or NO)

Local or Central Station Reporting System (New Program Only)

Press the NEXT/YES button for all zones to report; press the PRIOR/NO button for local system

```
Exit/Entry Zones
Enter Zone # XX
```

(Direct Entry)

Exit/Entry Zones in Area 1 (New Program Only)

- Enter the zone numbers of zones to be used as Exit/Entry zones.
- Valid entries are from 01 to 16. Directly enter each zone number, including leading zeros.
- Press **[SAVE]** to save and repeat for any additional zone(s); press the NEXT/YES button to proceed.

NOTE: Exit/Entry Entry time of 30 seconds will automatically be programmed.

```
Interior Zones
Enter Zone # XX
```

(Direct Entry)

Interior Zones in Area 1 (New Program Only)

- Enter the zone numbers to be used as Interior Zones.
- Valid entries are from 01 to 16. Directly enter each zone number, including leading zeros.
- Press **[SAVE]** to save and then repeat for any additional zone(s).
- Press the NEXT/YES button to proceed.
- All Interior zones will also be automatically programmed as "Exit/Entry Follower" and as "Power Up Delay" zones.

```
24 Hour Zones
Enter Zone # **
```

(Direct Entry)

24 Hour Zones in Area 1 (New Program Only)

- Enter the zone numbers of zones to be used as 24 Hour zones.
- Valid entries are from 01 to 16. Directly enter each zone number, including leading zeros.
- Press **[SAVE]** to save and repeat for any additional zone(s); press the NEXT/YES button to proceed.

NOTE: 24 Hour Zones will automatically be programmed as audible (Burg Output).

```
Chime Zones
Enter Zone # **
```

(Direct Entry)

Chime Zones in Area 1 (New Program Only)

- Enter the zone numbers which are to be used as Chime Zones.
- Valid entries are from 01 to 16. Directly enter each zone number, including leading zeros.
- Press  to save, then repeat for any additional zone(s), press the NEXT/YES button to proceed.

NOTE: A chime time of 2 seconds will be automatically programmed.

```
Chime 2 Zones
Enter Zone # **
```

(Direct Entry)

Chime 2 Zones in Area 1 (New Program Only)

- Enter the zone numbers which are to be used as Chime 2 Zones.
- Valid entries are from 01 to 16. Directly enter each zone number, including leading zeros.
- Press  to save, then repeat for any additional zone(s), Press the NEXT/YES button to proceed.

NOTE: A chime time of 2 seconds will be automatically programmed.

Chime 2 zones give a distinct pulsating tone when zone is faulted.

```
Exit/Entry2 Zones
Enter Zone # **
```

(Direct Entry)

Exit/Entry2 Zones in Area 1 (New Program Only)

- Enter the zone numbers of zones to be used as Exit/Entry zones.
- Valid entries are from 01 to 16. Directly enter each zone number, including leading zeros.
- Press  to save and repeat for any additional zone(s); press the NEXT/YES button to proceed.

NOTE: An Exit/Entry 2 Entry Time of 30 seconds will automatically be programmed.

```
50mS Loop Zones
Enter Zone # **
```

(Direct Entry)

50 mS Loop Response Zones (New Program Only) Note: 750mS is required for Loop Response time in UL installations.

- Enter the zone numbers of zones to be have a 50mS loop response.
- Valid entries are from 01 to 08. Directly enter each zone number, including leading zeros.
- Press  to save and then repeat for any additional zone(s), Press the NEXT/YES button to proceed.

Note: Only panel zones 01-08 can be programmed for Quick Loop Response. All other zones can be programmed via their respective EZM's (hardware). Time can also be adjusted via address 2280.

```
Aux Output Zones
Enter Zone # **
```

(Direct Entry)

Aux Output Activated on Alarm Zones (New Program Only)

- Enter the zone numbers of zones to activate the PGM2 upon alarm.
- Valid entries are from 01 to 16. Directly enter each zone number, including leading zeros.
- Press  to save, then repeat for any additional zone(s), Press the NEXT/YES button to proceed.

NOTE: A PGM2 Timeout of 15 minutes will automatically be programmed.

```
Sensor Watch Zns
Enter Zone # **
```

(Direct Entry)

Sensor Watch Zones (New Program Only)

- Enter the zone numbers of zones to be Sensor Watch zones.
- Valid entries are from 01 to 16. Directly enter each zone number, including leading zeros.
- Press  to save, then repeat for any additional zone(s), Press the NEXT/YES button to proceed.

NOTE: A Sensor Watch Time of 24 hours will automatically be programmed.

```
KP Sndr Alrm Zns
Enter Zone # **
```

(Direct Entry)

Keypad Sounder On Alarm Zones (New Program Only)

- Enter the zone numbers of all zones to activate the Keypad Sounder upon alarm.
- Valid entries are from 01 to 16. Directly enter each zone number, including leading zeros.
- Press  to save, then repeat for any additional zone(s), Press the NEXT/YES button to proceed.

```
Auto Byp REnt Zn
Enter Zone # **
```

(Direct Entry)

Auto Bypass Re-entry Zones (New Program Only) (Not Evaluated by UL)

- Enter the zone numbers of zones to be Auto Bypass Re-entry zones.
- Valid entries are from 01 to 16. Directly enter each zone number, including leading zeros.
- Press  to save, then repeat for any additional zone(s), Press the NEXT/YES button to proceed.
- Auto Bypass Re-entry Zones allow the system to be armed with the zone faulted but come back into the system (armed) when the zone is subsequently closed.

```
Enable No EOLR
Zones Y/N
```

(Press YES or NO)

Enable No EOLR Zones (New Program Only)

- Press YES to program all zones except 24 Hr & fire zones for No End Of Line Resistor. Press NO to continue. Do NOT program this feature for UL installations.

```
Enable Telco
Line Test? Y/N
```

(Press YES or NO)

Enable Telco Line Fault Test?

- Press YES to enable Telco Line Fault Test.
- Press NO to continue. **NOTE: If enabled, a Telco Line Fault Test Delay of 60 sec. will automatically be programmed.**



Enable Burg Out Chirp? Y/N

(Press YES or NO)

Enable Burg Output Chirp on Keyfob?

- Press the NEXT/YES button to enable Burg Output Chirp on Keyfob Arm / Disarm.
- Press the PRIOR/NO button to continue.

NOTE: The Burg Output will chirp once on Keyfob Arm and twice on Keyfob Disarm.

Enable SIA CP-01? Y/N

(Press YES or NO)

Enable SIA CP-01 Features?

- Press the NEXT/YES button to enable.
- Press the PRIOR/NO button to continue.

The SIA CP-01 Features are designed to reduce the incidence of false alarms. **NOTE:** Do not enable unless reporting, otherwise system trouble *Fail to Communicate* may occur.

Area 1 Keypads Enter # KPs 01

(Direct Entry)

Number of Keypads in Area 1

- Enter the total number of Keypads to be installed in Area 1.
- Valid entries are from 01 to 07. Directly enter the number of keypads, including leading zeros. Press to save. Press the NEXT/YES button to proceed.

Central Phone #

(Direct Entry)

Central Station Receiver 1 Telephone Number

- Enter telephone number of up to 16 digits.
- Press through for digits 1–9; for a zero and for a blank (*).
- Press through for letters B–F, respectively.
- Pre-Dial Delay = “D” (); Dial-Tone Detection = “E” ().
- Press to save and press the NEXT/YES button to proceed.

NOTE: Central Station Receiver 2 and 3 Telephone Numbers must be entered in Direct Address Programming. See CS Receiver Options.

Central Station Account # (____)

(Direct Entry)

Central Station Receiver 1 Account Number

- Enter an account number of up to four digits.
- Press through for digits 0–9, and for a blank (*).
- Press to save and press the NEXT/YES button to proceed.

NOTE: Central Station Receiver 2 and 3 Account Numbers must be entered in Direct Address Programming. See CS Reporting Options.

See WI for Info Rcvr Format (0)

(Direct Entry)

Central Station Receiver 1 Format

- From the table at the right enter the receiver format.
- Press through , and for blank (*).
- Press through for letters B–E.
- Press to save; press the NEXT/YES button to proceed.

DATA ENTRY	CS RECEIVER 1 FORMAT
• (blank)	Ademco Slow, Silent Knight Slow
2	Radionics Fast
3	Silent Knight Fast
4	Radionics, DCI, Franklin Slow
5	Universal High Speed
B	SIA
C	Ademco Point ID
E	Pager

Enter user code-> U01 123 - 9-

User# User Code Area 1

Enter User Codes (Press to set cursor.)

For default program, enter up to 16 User Codes, with Area 1 Options.

- Press the () button once to set the cursor to the User Code.
- Press through to enter a code from 3 to 6 digits, leave blank (*) any trailing boxes.
- Press to set the cursor to the Area 1 Options Level. Refer to the table below for available options.

- If “Enable Global Ambush Code” (Address 1422) is enabled and “Global Ambush Code” (Address 2045) is **not** left blank (*), *do not* program the first two digits of ANY User Code the same as the “Global Ambush Code”. See Address 2045 further in this manual for more information.
- Press to save. **Note:** Duplicate User Codes are not allowed; therefore a duplicate Code entered in the LCD Window will erase when is pressed. To proceed to the next User Code, press to set the cursor to the User Number and change it using the number buttons. Press the NEXT/YES button to proceed.

USER OPTIONS	
USER CODE (UP TO 6 DIGITS)	AREA 1 OPTIONS

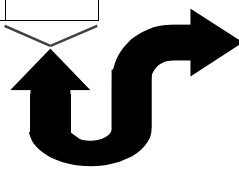

USER AREA OPTIONS		
DATA ENTRIES		OPTION ENABLED
L	R	
blank(*)	blank(*)	Disabled
blank(*)	1	Arm/Disarm
blank(*)	2	Arm Only
blank(*)	3	Service
blank(*)	4	Access
blank(*)	5	Ambush
blank(*)	Add 8	* User Program
4	blank(*)	Bypass Enable



Example: Program a code of “2222” for user 02, with area 1 options of “Arm/Disarm” and “User Program”. Enter “2222” for a user code, “• (blank) 9” for area 1 options.

AREA OPTIONS	EXPLANATION
Disabled	User Code not active.
Arm/Disarm	Allows User Code to arm/disarm.
Arm Only	Prevents User Code from disarming.
Service	A Service Code has restricted arm/disarm rights; if an area is armed with a Service Code, a "MONITOR ON" appears on the GEM-RP2ASe2 keypad and the area can be disarmed with any valid User Code, including a Service Code. If the area is armed with OTHER than a Service Code, it CANNOT be disarmed with a Service Code. This is typically used to allow tradesmen access to premises under control of the owner.
Ambush	There are two types of Ambush Codes: (1) A 2-digit code (prefix) that is entered immediately prior to (and as part of) the regular User Code and (2) A separate and unique User Code. Disarming with an Ambush Code will cause a silent report to be sent to a central station. Thus, should a user be forced to disarm, he can silently signal an emergency while appearing to be merely disarming the system.
Access	This is normally used to activate a door strike while an area is disarmed. Also program "Access Control on PGM2. Output" (Address 0719) and "PGM2 Output Access Control Timeout" (Address 0711).
* User Program	User Program Option is enabled. To enable User Program Option for any user, add 8 to the data entry for Area Option (see example). Then, User Programming can be performed at any Keypad by a user code with user program enabled.
Bypass Enable	Security Bypass--Bypass is enabled only with a security code.

Related User Options: "Enable Global Ambush Code" (Address 1422), "Global Ambush Code" (Address 2045) & "Enable Manager's Mode" (Address 1421).

CHANGING OR CANCELING A CODE: To change any code, merely program over the existing code as described above and press  to save. Similarly, to cancel a code, blank out each number of the code and press  to save.















ZN#	XMIT#	CS	P
Zn01-	000000:	0-	0

Zone # Xmitter Check Point
Mapped to ID Sum #

RF Transmitter Points (Press to set cursor.)

For each transmitter enter: (For wireless systems only. Also see Quick Method, which follows)

- The **zone number** (01–16) to which the transmitter will be mapped.
- The **6-digit RF ID #** and **1-digit checksum number** printed on the transmitter and box,
- The **point number** (1 or 2); enter "9" for *unsupervised* (all points).
- Press  to save and NEXT/YES button to proceed when all transmitters have been entered.

NOTE: When programming the ID Code number, "0" through "9" =  through ; A =  ; B =  ; C =  ; D =  ; E =   and "F" =  .

Quick "Enroll" Method: If a receiver is already installed in the panel, transmitter wireless points can be programmed automatically ("enrolled") using the following procedure. **NOTE:** The transmitter point will be enrolled only if the signal strength is 3 or greater.

ZN#	XMIT#	CS	P
Zn01-	000000:	0-	0

1. Enter the zone number to which the transmitter point will be mapped.
2. Press  to enter the Enroll Mode. The red and green LEDs on the keypad will flash and the window will display as shown at left.
3. Open the loop of the point that is to be programmed (GEM-TRANS2 only).
4. Install the transmitter battery. The keypad will beep to indicate that the point has been successfully enrolled. Multi-point transmitters can be mapped to successive zones simultaneously.

ZN#	XMIT#	CS	P
ZN01-	ENROLL:	A--	--

Example. A 2-point transmitter has the RF ID number 287613:1. Map point 1 to Zone 6 and point 2 to Zone 9.

1. Enter the Enroll mode as described above.
2. Enter Zone "06".
3. Open point-1 loop.
4. Install the battery. The keypad will beep once to indicate that one point has been programmed. (Transmitter 287613:1, point 1 will be mapped to Zone 6).
5. Enter Zone "09".
6. Close point-1 loop and open point-2 loop.
7. Remove the transmitter battery, then re-install it. The keypad will beep once to indicate that one point has been programmed. (Transmitter 287613:1, point 2 is mapped to Zone 9).

KEYFOB ZONE ASSIGNMENT: Keyfobs can also be assigned to zones to allow multiple wireless panic buttons on one alarm system, each reporting to a central station, a pager or having a description on the keypad that describes the person holding the keyfob, the location where the person holding the keyfob is stationed, or the special purpose of the keyfob button being depressed. See the next page on Keyfob Transmitters as Zone Input Devices.















KF	A	XMIT#	CS	OP
01-	0	000000:	0	00

KF Area Xmitter Check Aux
Area ID Sum 1&2

Keyfob Transmitters as Arm/Disarm & Control Devices (Press to set cursor).

Keyfobs can be programmed as "Arm/Disarm" devices using their On/Off buttons (refer to WI752). For each Keyfob Transmitter, enter:

- The **Keyfob Transmitter number** (1–8).
- The **area number** to which transmitter is assigned (1 or 0 to disable keyfob).
- The **6-digit RF ID #** and **1-digit checksum number** printed on the transmitter and box,
- The **Aux 1 Option** (see keyfob aux 1 & aux 2 options).
- The **Aux 2 Option** (see keyfob aux 1 & aux 2 options).
- Press  to save and NEXT/YES button to proceed when all keyfobs have been entered.

NOTE: When programming the ID Code number, "0" through "9" =  through ; A =  ; B =  ; C =  ; D =  ; E =   and "F" =  .



Keyfob Transmitters as Zone Input Devices

(Refer to display above: press the AWAY button to go backwards).

Each of the 4 keyfob buttons can be assigned to a zone. For example, On button = point 1; Off button = point 2; A1 = point 3; A2 = point 4. Up to 16 keyfobs (using 1 button) or 8 keyfobs (using 2 buttons) or 4 keyfobs (using all 4 buttons) or any combination up to a maximum of 16 controlled zones can be assigned, providing multiple wireless panic buttons on a system, each reporting to a Central Station or a pager and/or annunciating on a keypad the keyfob zone number with a description. To assign a keyfob to a zone: program the keyfob as you would a transmitter, entering the keyfob's ID code, check sum and point number at the appropriate zone. The "Quick Method" is not allowed. The zone may be hardwired to an electrical sensor as well as assigned to a keyfob (either one will activate the zone alarm output). **NOTE:** If assigning a keyfob to a zone, the "ON/OFF" buttons on the keyfob will no longer arm/disarm the system. The keyfob is converted to a "panic only" device.

DATA ENTRY	AUX 1/AUX 2 OPTIONS
0	None
1	Relay Group 1 Toggle
2	Relay Group 2 Toggle
9	Keypad Panic
A	Keypad Aux.
B	Instant
C	PGM2 Output Toggle
D	Access on PGM2 Output
E	Arm STAY
F	Interior Button

01-

(Direct Entry)

Enter Zone Descriptions

- For each zone, enter a description of up to two lines. Press to save each description.
- See page 41 for instructions for entering characters and numbers for the zone descriptions.
- To proceed to the next description, place the cursor under the Zone Number (e.g. "1") and press the number that corresponds to the zone. Program new description as above. **NOTE:** Zone Descriptions can only be entered through the GEM-RP1CAe2 Keypad or by using the Napco Quickloader Software. See Easy Menu Programming Worksheet for available zone description characters.

Enter Date
(/ /)

(Direct Entry)

Enter Date (Press to set cursor).

- Enter the current date in the format MM/DD/YY. (MM = month, DD = day and YY = year.
- Press to save. Press the NEXT/YES button to proceed.

Enter Time
(:)

(Direct Entry)

Enter Time (Press to set cursor.)

- Enter the current time in format HH:MMA/P, where HH=hours (01-12); MM=minutes (00-59).
- Select AM or PM by pressing any number button.
- Press to save. Press the NEXT/YES button to proceed.

Dealer Code
456789

Dealer Code

- Directly enter the Dealer Code (default = 456789), using through buttons.
- Press to save. Re-enter the Dealer Code to verify the previous code. Press to save.
- Press the NEXT/YES button to proceed.

DEALER CODE
RE-ENTER

TEST TIMER
SMTWTFS HH:MM

Test Timer

- Select day(s) by simply erasing the unwanted days. Move the cursor over the day and press any number key to erase/restore the day. For example, "Monday" and "Friday" will appear as: ".M...F."
- Enter Time (in 24 hour format) by moving cursor under the left H and pressing two digits to overwrite the existing default of 00. **Note:** Midnight is 00:00. Enter minutes by continuing to enter data or if just updating minutes move the cursor under the left M and enter the two digits to overwrite the existing default of 00. Use as right cursor one position.

EXIT DEALER PROGRAM MODE: This completes the custom default program. Press to enter the Direct Address Program Mode for further programming or press once again to end all programming and resume normal keypad operation.

CLEAR PROGRAM: Should it be necessary to create a new custom default program, (a) from the Dealer Program Mode, press to enter the Address Program Mode; (b) access Location 2285 (Clear Program) or 2286 (Cold Start); (c) press and then (d) press to exit the Dealer Program Mode. A "SYSTEM TROUBLE/E09-00 SERVICE" will occur. Press to silence the keypad.

Clear Dealer Program (Erases Dealer Program)

Use this feature to erase the Panel Program, while maintaining Scheduled Data and Zone Descriptions. Access address 2285 and press . Data entry is not allowed. **NOTE:** Enter Easy Menu Driven Program Mode to reprogram system.

2285 XX H

Cold Start (Erases Entire Program)

This erases all programmed data (Dealer Program, Zone Description Data and Schedules). Access address 2286 and press . Data entry is not allowed. **NOTE:** Some features (schedules) can only be programmed again with the Downloading Software.

2286 XX H

DIRECT ADDRESS PROGRAM MODE

DIRECT ADDRESS OVERVIEW

Direct Address Programming allows you to go directly to the address locations (up to 2287) and change the data entries manually in order to customize your control panel options. Whereas the Easy Menu Program Mode guides you through limited selections to get you started, **Direct Address Program Mode** allows you to change all options directly. It consists of up to 2287 address locations each with data entry locations as shown in the following diagram (below left). The data entry location accepts data in one of three formats: Binary, Decimal and Hexadecimal (explained below in "Address Mode Displays"). The following diagram (below right) illustrates a *Decimal* format data entry location (using a GEM-RP1CAe2 keypad).

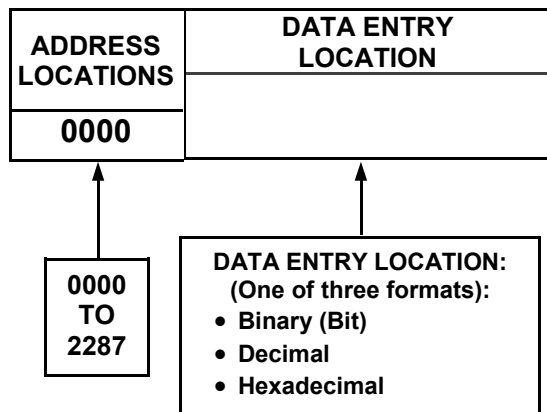

GEM-RP1CAe2 Keypad Display Example

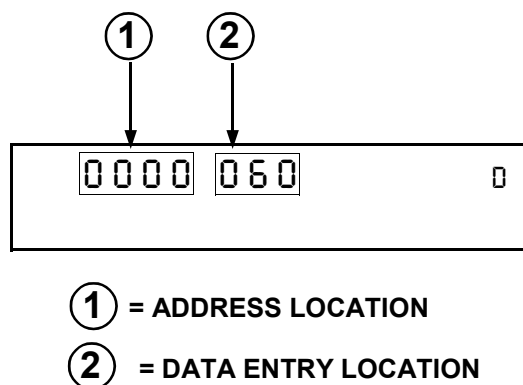

ADDRESS MODE DISPLAYS

There are three types of address displays when programming in Direct Entry Program Mode, as follows:

A) Binary (Bit) Format Example

Settings (such as Zone Features) display and accept data in "number" format. For example, Zone Features are turned on by the pressing of keypad buttons 1 through 8, with the activated Zone(s) displaying the corresponding decimal digit (replacing deactivated zones which are signified by dashes).

EXAMPLE: BIT Format with the GEM-RP1CAe2: Program Zones 2, 4, 5 and 7 as *Exit/Entry Follower Zones*.

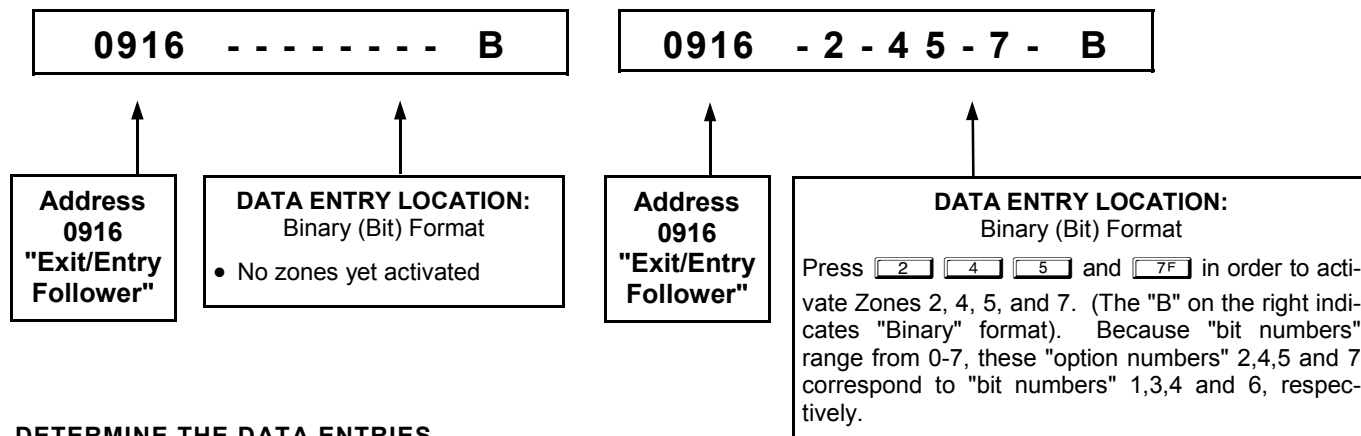

DETERMINE THE DATA ENTRIES

1. Referring to ZONE FEATURES in the Programming Worksheets that follow, the Exit/Entry Follower for Zones 1 through 8 are located at address 0916.

ZONE FEATURES	ADDR	ZONES 1 → 8								ADDR	ZONES 9 → 16							
		Z1	Z2	Z3	Z4	Z5	Z6	Z7	Z8		Z9	Z10	Z11	Z12	Z13	Z14	Z15	Z16
		1	2	3	4	5	6	7	8		1	2	3	4	5	6	7	8
Exit/Entry Follower	0916						6	7	8	0911								

PROGRAM THE DATA ENTRIES

1. Enter the panel's Dealer Security Code, then press **[MENU]**.
2. Answer NO to all questions until "ACTIVATE PROGRAM Y/N" is displayed; then press YES. **NOTE:** If you pass "ACTIVATE PROGRAM", scroll backward using **[BYPASS]**.
3. Press **[RESET]** to enter the Address Program Mode. Address "0000" will display.
4. Press **[0]** **[9P]** **[1]** **[6]** to access Address 0916. *The existing data will display and the cursor will advance to the data field.*
5. Press **[6]** **[7F]** **[8A]**. The numbers 6,7 and 8 will appear on the keypad display indicating the zones activated.
6. Press **[ENTER]** to save. Address 0916 is now programmed with "6,7,8".
7. Press **[MENU]** and enter another 4-digit address to continue programming --or-- press **[RESET]** to exit and resume normal keypad operation.

B) Decimal Format Example

Settings (such as Entry and Exit Delay) display and accept data in decimal format, as a 3 digit number. Data is entered directly, by pressing keys 0 – 9, with the cursor automatically moving to the right upon each key press.

EXAMPLE: DECIMAL Format with the GEM-RP1CAe2: Program *Abort Delay* to be 15 seconds.

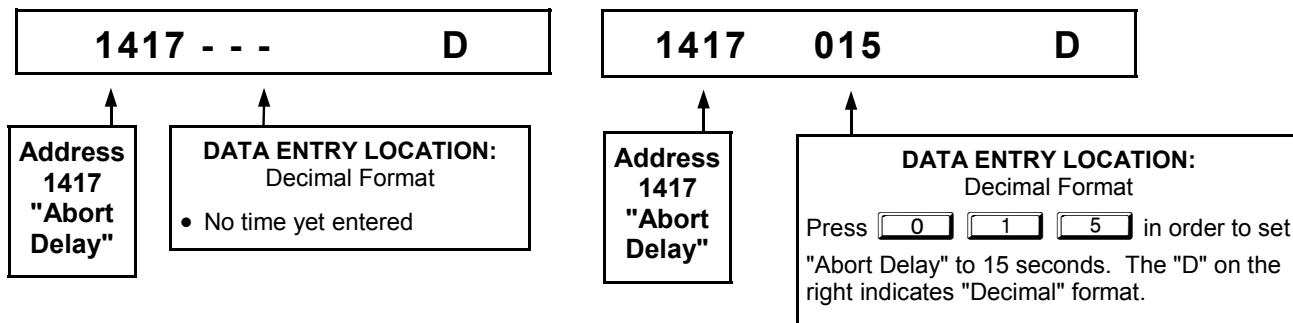

DETERMINE THE DATA ENTRIES

1. Referring to SYSTEM DELAYS & TIMEOUTS in the Programming Worksheets that follow, the Abort Delay is located at address 1417:

ABORT DELAY (sec.)	ADDRESS 1417		

[Default = 0 sec. = blank (*)]

PROGRAM THE DATA ENTRIES

1. Enter the panel's Dealer Security Code, then press **[MENU]**.
2. Answer NO to all questions until "ACTIVATE PROGRAM Y/N" is displayed; then press YES. **NOTE:** If you pass "ACTIVATE PROGRAM", scroll backward using **[BYPASS]**.
3. Press **[RESET]** to enter the Address Program Mode. Address "0000" will display.
4. Press **[1]** **[4]** **[1]** **[7F]** to access Address 1417. *The existing data will display and the cursor will*

advance to the data field.

5. Press . The numbers 015 will appear on the keypad display indicating the number of seconds entered.
6. Press to save. Address 1417 is now programmed with a 15-second Abort Delay.
7. Press and enter another 4-digit address to continue programming--or--press to exit and resume normal keypad operation.

C) Hexadecimal Format Example

Data such as Report Codes displays and accepts data by means of a Hexadecimal display. Data is entered directly, by pressing keys 1 – 9, for zero, and through for hex B through F (11-15), with the cursor automatically moving to the right upon key press. See table below.

HEXADECIMAL ENTRIES					
ENTRY TOTAL	PRESS	KEYPAD DISPLAYS	ENTRY TOTAL	PRESS	KEYPAD DISPLAYS
blank	<input type="button" value="0"/>	•	8	<input type="button" value="8"/> <input type="button" value="A"/>	8
1	<input type="button" value="1"/>	1	9	<input type="button" value="9"/> <input type="button" value="P"/>	9
2	<input type="button" value="2"/>	2	10	<input type="button" value="*"/> <input type="button" value="0"/>	0
3	<input type="button" value="3"/>	3	11	<input type="button" value="*"/> <input type="button" value="1"/>	B
4	<input type="button" value="4"/>	4	12	<input type="button" value="*"/> <input type="button" value="2"/>	C
5	<input type="button" value="5"/>	5	13	<input type="button" value="*"/> <input type="button" value="3"/>	D
6	<input type="button" value="6"/>	6	14	<input type="button" value="*"/> <input type="button" value="4"/>	E
7	<input type="button" value="7"/> <input type="button" value="F"/>	7	15	<input type="button" value="*"/> <input type="button" value="5"/>	F

EXAMPLE: HEXADECIMAL Format with the GEM-RP1CAe2: Program *Chime Timeout* to be 2 seconds.

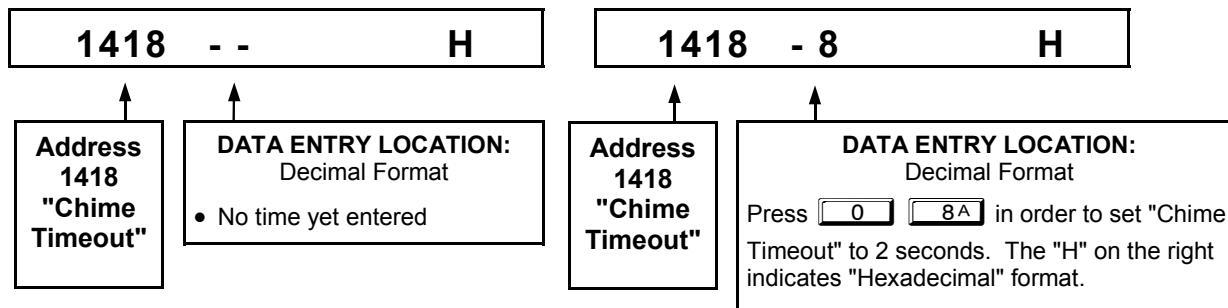

DETERMINE THE DATA ENTRIES

1. Referring to SYSTEM DELAYS & TIMEOUTS in the Programming Worksheets that follow, the Chime Timeout is located at address 1418. In the "Chime Timeout Options" table, the data entries needed to assign a timeout of 2 seconds are "blank" and "8".

CHIME TIMEOUT	ADDRESS 1418	
(1/4sec.)		

[Default = 2 1/4sec. = 1/2 sec.]

CHIME TIMEOUT OPTIONS		
DATA ENTRIES		TIMEOUT
LEFT	RIGHT	
blank (*)	blank (*)	0 x 1/4sec. = 0 sec.
blank (*)	2	2 x 1/4sec. = 1/2 sec.
blank (*)	3	3 x 1/4sec. = 3/4 sec.
blank (*)	4	4 x 1/4sec. = 1 sec.
blank (*)	5	5 x 1/4sec. = 1.25 sec.
blank (*)	6	6 x 1/4sec. = 1.5 sec.
blank (*)	7	7 x 1/4sec. = 1.75 sec.
blank (*)	8	8 x 1/4sec. = 2 sec.
F	F	255 x 1/4sec. = 63.25

← 2 seconds

PROGRAM THE DATA ENTRIES

1. Enter the panel's Dealer Security Code, then press **[MENU]**.
2. Answer NO to all questions until "ACTIVATE PROGRAM Y/N" is displayed; then press YES. **NOTE:** If you pass "ACTIVATE PROGRAM", scroll backward using **[BYPASS]**.
3. Press **[RESET]** to enter the Address Program Mode. Address "0000" will display.
4. Press **[1]** **[4]** **[1]** **[8A]** to access Address 1418. *The existing data will display and the cursor will advance to the data field.*
5. Since you wish the timeout to be for 2 seconds (and 8 multiplied by ¼ second equals 2 seconds), press **[0]** **[8A]**. The numbers 08 will appear on the keypad display indicating the number of seconds entered.
6. Press **[SAVE]** to save. Address 1418 is now programmed with a 2-second chime.
7. Press **[MENU]** and enter another 4-digit address to continue programming --or-- press **[RESET]** to exit and resume normal keypad operation.

PROGRAMMING CONVENTIONS USED IN THIS MANUAL

The Keypad Programming Worksheets in the back are provided as an address-programming reference to help the installer modify his custom default program or to make minor field alterations to an existing panel program. It is recommended that the panel be uploaded to NAPCO's PCD-Windows software following any keypad programming and that the PCD-Windows's error-check feature be utilized to reduce the possibility of programming omissions or conflicts.

Keep the Keypad Programming Worksheets on file for future reference.

General Programming Steps

1. Contact the central station to ascertain receiver format, data format, event codes, subscriber numbers and telephone number(s).
2. Select the desired features by circling  the respective "address" boxes. Refer to the Programming Options and Worksheets for guidance in selecting the "data" to be entered into those boxes.
3. Program the data entered in the boxes on the worksheets into the respective addresses. The display will show the entry numerically, but if hexadecimal format will display "0" for the number 10, and letters "B", "C", "D", "E", and "F" for the numbers 11 through 15, respectively. To program a 10, press **[*]** **[0]**. To program 11 through 15, press **[*]** **[1]** through **[*]** **[5]**, respectively.

The displays will appear after a brief delay.

- Use **[MENU]** to toggle the cursor between the 4-digit address field and the data entry locations.
- Enter the address directly using the number buttons.
- The contents of the address will be read automatically. The cursor will advance to the data field. Enter the required data directly using the number buttons.
- IMPORTANT:** Press **[SAVE]** to save the contents of each address.

EXIT DIRECT ADDRESS PROGRAM MODE: When done, press **[RESET]** to exit and resume normal keypad operation.

SYSTEM DELAYS & TIMEOUTS (ADDRESS 0000-0002, 1413, 1417, 2050 & 2055)

EXIT DELAY (sec.)	ADDRESS 0000		

[Default = 060]

ENTRY DELAY 1 (sec.)	ADDRESS 0001		

[Default = 030]

ENTRY DELAY 2 (sec.)	ADDRESS 0002		

[Default = 030]

PGM2 Output Access Cntrl Timeout (sec.)	ADDRESS 1413		

[Default = 0 sec. = blank (*)]

ABORT DELAY (sec.)	ADDRESS 1417		

[Default = 030]

 Select delay/timeout (0-255 sec.).

EXIT/ENTRY DELAYS: Apply only to zones programmed with the following options "Exit/Entry 1, Exit/Entry 2, Exit/Entry Follower". For UL Installations, the maximum exit delay is 60 seconds and the maximum entry delay is 45 seconds. **NOTE:** Sensor Watch Time Options are similar to above, except in hours.

 Press  to save.

Sensor Watch Time (Hrs.)	ADDRESS 2050		

[Default = 024]

Report Cancel Window (min.)	ADDRESS 2055		

[Default = 0 min. = blank (*)]

WARNING: Timers have uncertainty of +/-1 sec, so a "time" of 1 second may actually timeout IMMEDIATELY.

SYSTEM DELAYS & TIMEOUTS (ADDRESS 1418-1419)

CHIME TIME (%sec.)	ADDRESS 1418		

[Default = 008 x ¼ sec. = 2 sec.]

AC Fail Report Delay (min.)	ADDRESS 1419		

[Default = 060]

DEFAULTS: The defaults shown on this page and on the following pages are automatically set after exiting the Easy Menu Driven Mode.

 1. Enter delay/timeout in corresponding address locations above.

Note: All entries for address 1418 are in quarter seconds (.25 seconds). Therefore, the default of 008 results in a 2 second timeout.

 2. Press  to save.

SYSTEM OUTPUT TIMEOUTS (ADDRESS 1412 & 1414-1416)

PGM2 Output	ADDRESS 1412		
Timeout (min.)			

[Default = 0 min. = blank (*)]

Alarm Output	ADDRESS 1414		
Timeout (min.)			

[Default = 015]

Pulse Alarm Output	ADDRESS 1415		
Timeout (min.)			

[Default = 015]

PGM1 Output	ADDRESS 1416		
Timeout (min.)			

[Default = 0 min. = blank (*)]

DATA ENTRIES	DELAY/TIMEOUT
blank (*)	0 min.
001	1 min.
002	2 min.
003	3 min.
004	4 min.
005	5 min.
006	6 min.
016	16 min.
↓	↓
255	255 min.

1. Select delay/timeout (0-255 min.) from the table shown.
2. Enter in corresponding address locations above.
3. Press to save.

OUTPUT TIMEOUTS: If a timeout of "0 min." is selected, then the output will remain active (ON) until the system is reset or disarmed. For UL Residential Installations, the minimum timeout is 4 minutes. Not UL listed for Commercial Installations.

DOWNLOAD/CALLBACK OPTIONS (ADDRESS 2059 & 0526-0545)

No. Rings Before Pickup	ADDRESS 2059		
[]			

[Default = 015]

NUMBER OF RINGS BEFORE PICKUP: Enter the number of rings before automatic pickup by the control panel when downloading from a computer (see Glossary at the back for more information).

1. Enter digit only.
2. Valid entries are: 003-015. **NOTE:** Default is 15 Rings.
3. Press to save.

Callback Telephone Number (Digits 1-20)	ADDRESS 0526-0545 (RIGHT DIGITS 1-20)																			
	0526	0527	0528	0529	0530	0531	0532	0533	0534	0535	0536	0537	0538	0539	0540	0541	0542	0543	0544	0545
[]	[]	[]	[]	[]	[]	[]	[]	[]	[]	[]	[]	[]	[]	[]	[]	[]	[]	[]	[]	[]

[Default = blank (*) for all digits 1-20]

CALLBACK TELEPHONE NUMBER: Enter telephone number to be used when downloading from a computer (see Glossary at the back for more information).

1. Enter digit only (right nibble).
2. Enter up to 20 digits from left to right. **NOTE:** Leave trailing boxes blank (*).
3. Valid entries are: 1-9, B = , C = , D = 3 sec. pause, E = Wait for dial tone, F = ignore location.
4. Press to save.

PAGER FORMAT OPTIONS (ADDRESS 0546 & 0547)

Leading Digits for Pager Format (1st Digit)	ADDRESS 0546
[]	
Leading Digits for Pager Format (2nd Digit)	ADDRESS 0547
[]	

[Default = blank (*) blank (*)]

LEADING DIGITS FOR PAGER FORMAT: In Pager Format reporting, the message typically begins with "00". However, for some pager services, this will cause the Pager's Voice Mail feature to activate. This option allows you to program these digits to any number desired. A typical Pager report is "003 22 1234", where 3 is the Event, 22 is the zone, and 1234 is the Subscriber ID number. For example, if the Leading Digits are programmed as "98", the Pager report will now appear as "983 22 1234". **NOTE:** See CS Receiver Options to select Pager Format.

1. Enter in 1st and 2nd Leading Digits as shown (right nibble).
2. Valid entries are: 0-9. Press to save.

SYSTEM OPTIONS (ADDRESS 0836-0863 & 2045)

SYSTEM RESPONSE ACTIVATED BY GLOBAL EVENT/TROUBLE	ADDR	GLOBAL SYSTEM EVENT/TROUBLE							
		TEST TIMER	TELCO FAILURE	RF RCVR. TROUBLE	MEMORY FAILURE	LOW BATTERY	AC FAIL	EZM TAMPER	Bell Superv
		1	2	3	4	5	6	7	8
Alarm Output	0836								
Pulsed Alarm Output	0837								
PGM1 Output	0838								
PGM2 Output	0839								
Report Event Telco 1	0840								
Report Restore Telco 1	0841								
Report Event Telco 3	0842								
Report Restore Telco 3	0843								



[Default = blank (*) from address 0836-0843]. **Note:** If Test Timer is enabled (above), Digital Dialer Test is also enabled.

SYSTEM RESPONSE ACTIVATED BY AREA 1 EVENT/TROUBLE	ADDR	AREA 1 SYSTEM EVENT/TROUBLE							
		AMBUSH	KEYPAD PANIC	KEYPAD FIRE	KEYPAD AUX.‡	KEYPAD TAMPER	FAIL TO OPEN	FAIL TO CLOSE	Keyfob Low Batt
		1	2	3	4	5	6	7	8
Pulsed Alarm Output	0856								
Alarm Output	0857								
PGM1 Output	0858								
PGM2 Output	0860								
Report Event Telco 1	0861								
Report Event Telco 3	0863								

[Default = blank (*) from address 0856-0863] ‡ **NOTE:** Keypad Aux. is not to be selected for UL Installations.

 1. Select the desired option entering the option number (1-8) for each digit.

 2. Enter corresponding option number in address location.

 **NOTE:** Dark shaded data value box shows option not available. Press  to save.

Global Ambush Code	ADDRESS 2045	
	1st digit	2nd digit

[Default = blank (*) blank (*)]

GLOBAL AMBUSH CODE: It is the 2-digits entered immediately prior to the regular disarm code. If “Enable Global Ambush Code” (Address 1422) is selected and Address 2045 is left blank (*), then the 2-digit Global Ambush Code is “99”. If “Enable Global Ambush Code” is selected and Address 2045 is **not** left blank (*), then the 2-digit Global Ambush Code is the two digits entered in address 2045.

 Enter in address location (both 1st and 2nd digits); valid entries are 1-9.

 Press  to save.

THIS PAGE INTENTIONALLY LEFT BLANK

SYSTEM OPTIONS (ADDRESS 1420-1424, 2051-2054)

1420 System Options		
Default		Option
OFF	1	Opening Report Only after Alarm Report
OFF	2	Closing Report Only on Conditional Close
OFF	3	Incl. Sel./Grp. Bypass in Cond. Close /Status
OFF	4	Status Report
OFF	5	RESERVED
OFF	6	Enable AutoArm if not closed at end of Window
OFF	7	Enable Keypad Time/Date Display
OFF	8	Disable Zone Fault Scrolling

1422 System Options		
Default		Option
OFF	1	Interior Normally Bypassed
OFF	2	Enable Global Ambush Code **
OFF	3	Reset Day Zone with Arm/Disarm Only
OFF	4	Enable Residential Fire
OFF	5	Disable Keypad Function Mode Download
OFF	6	Disable Callback Download
OFF	7	Chirp Output on Keyfob Arm/Disarm
OFF	8	Change Pulse Output to Temporal Output [§]

1424 System Options		
Default		Option
OFF	1	Automatic Interior Bypass/Easy Exit
OFF	2	Veri-phone Zones Trip PGM2 Output
OFF	3	Veri-phone Audio Priority Over Alarms
OFF	4	Resound on Wireless Smoke Low Battery
OFF	5	Don't Clear PGM2 Output with Disarm
OFF	6	Disable 2nd Call Ans. Machine Override
OFF	7	RESERVED
ON	8	Disable Code Required for EZ Bypass

2052 E15 Lug / System Options		
Default		Option
OFF	1	RESERVED
OFF	2	RESERVED
OFF	3	Lug E15 Area 1 Armed Away Only****
OFF	4	PGM on RF Transmitter Tamper [‡]
OFF	5	RESERVED
OFF	6	RESERVED
OFF	7	RESERVED
OFF	8	RESERVED

***NOTE:** To select "Line-Fault Test only when Armed", you must also select "Enable Line-Fault Test" at address 1423.

****NOTE:** If "Enable Global Ambush Code" in Address 1422 is selected, then program the 2-digit "Global Ambush Code" in Address 2045. If Address 2045 is left blank (*), then, the 2-digit "Global Ambush Code" will be "99".

*****Note:** If this feature is not selected, the E15 Lug will, by default, activate when the system is armed (in either STAY or AWAY mode).

[‡]Not for UL Installations

^{††}For reference only and cannot be changed.

[§]This feature must be programmed in Fire Alarm applications.

1421 System Options		
Default		Option
OFF	1	Auto Bell Test on Arming
OFF	2	Auto Reset after Burglary Output Timeout
OFF	3	Suppress Bypass Reminder when Armed
OFF	4	Enable Local Alarm on First Zone AND Trip
OFF	5	Access Control on PGM2 Output
OFF	6	Maintained Keyswitch Arming
OFF	7	Enable Manager's Mode
OFF	8	Disable Keypad Instant Mode

1423 System Options		
Default		Option
OFF	1	RESERVED
OFF	2	Wireless Trouble Activates Telco 1
OFF	3	Wireless Trouble Activates Telco 3
OFF	4	Enable Alarm Output on Telco Fail only when Armed
OFF	5	Line-Fault Test only when Armed*
OFF	6	Enable Line-Fault Test*
OFF	7	Inhibit System Trouble Audible at Keypad [‡]
OFF	8	Select Alarm Output for Keyfob Chirp

2051 System Options		
Default		Option
OFF	1	Enable Keypad Set Time/Date Message
OFF	2	Enable Cancel Report to Telco 3
OFF	3	Disable [ON/OFF] as Easy Exit
OFF	4	Enable GEM-PRINT Module
OFF	5	RESERVED
OFF	6	RESERVED
OFF	7	Disable System Trouble Audible Timeout
OFF	8	Enable "K Series" Style Keypads ^{††}

2053 System Options		
Default		Option
OFF	1	Exit Time Restart
OFF	2	Sound Alarm On Exit Error
OFF	3	Rpt Exit Err/Recent Close
OFF	4	Enable CP-01 Limits
OFF	5	Digital Dialer Rpt Enter /Exit Test Mode
OFF	6	Disable Call Waiting on 1st Attempt
OFF	7	Enable Keypad 1 Only Programming
OFF	8	Enable CP-01 Egress Tones Only

2054 System Options		
Default		Option
OFF	1	Enable TCP/IP Communications [‡]
OFF	2	RESERVED
OFF	3	TCP/IP Panel/Site Initiated Functions
OFF	4	RESERVED
OFF	5	RESERVED
OFF	6	RESERVED
OFF	7	RESERVED
OFF	8	RESERVED



CS RECEIVER OPTIONS (ADDRESS 0460-0525)

CS Receiver 1	ADDRESS 0460	
Format		

CS Receiver 2	ADDRESS 0482	
Format		

CS Receiver 3	ADDRESS 0504	
Format		

DATA ENTRY	CS RECEIVER 1 FORMAT
blank (*)	Ademco Slow, Silent Knight Slow
2	Radionics Fast
3	Silent Knight Fast
4	Radionics, DCI, Franklin Slow
5	Universal High Speed
B	SIA
C	Ademco Point ID
E	Pager *

Default for CS Receiver 1 Format depends on Easy Menu Question "RCUR FORMAT". [Default = *(blank) * (blank)] for CS Receivers 2 and 3 Formats.

CS RECEIVER FORMATS: Up to 3 CS Formats may be programmed.

1. Select the desired CS Receiver Format from the table shown.
2. Enter the corresponding digit in the address location for each CS Receiver. **NOTE:** Dark shaded data value box shows option not available. Press [Enter] to save.

NOTE: * See Pager Format Options to program Leading Digits for Pager Format.

0461	CS Receiver Options - Telco 1	
Default	Option	Option
OFF	1	1400Hz Handshake/Kissoff *
OFF	2	2300Hz Handshake/Kissoff *
OFF	3	Enable Zone Number on Pulse Alarm
OFF	4	Single Digit Only
OFF	5	Sum Check
OFF	6	3/1 with Extended Restores
OFF	7	Enable TCP/IP AES RPT
OFF	8	RESERVED

0483	CS Receiver Options - Telco 2	
Default	Option	Option
OFF	1	1400Hz Handshake/Kissoff *
OFF	2	2300Hz Handshake/Kissoff *
OFF	3	Enable Zone Number on Pulse Alarm
OFF	4	Single Digit Only
OFF	5	Sum Check
OFF	6	3/1 with Extended Restores
OFF	7	Enable TCP/IP AES RPT
OFF	8	RESERVED

0505	CS Receiver Options - Telco 3	
Default	Option	Option
OFF	1	1400Hz Handshake/Kissoff *
OFF	2	2300Hz Handshake/Kissoff *
OFF	3	Enable Zone Number on Pulse Alarm
OFF	4	Single Digit Only
OFF	5	Sum Check
OFF	6	3/1 with Extended Restores
OFF	7	Enable TCP/IP AES RPT
OFF	8	RESERVED

CS RECEIVER OPTIONS:

Select options for any of the three CS Receivers.

1. Select the desired option entering the option number (1-8) for each digit.
2. Enter corresponding option number in address location (right nibble).

NOTE: Dark shaded data value box shows option not available. Press [Enter] to save.

***NOTE:** If both are selected, 1400Hz has priority over 2300Hz.

CS Receiver 1	ADDRESS 0462-0481 (RIGHT DIGITS 1-20)																				
Telephone Number	0462	0463	0464	0465	0466	0467	0468	0469	0470	0471	0472	0473	0474	0475	0476	0477	0478	0479	0480	0481	
(Digits 1-20)																					

CS Receiver 2	ADDRESS 0484-0503 (RIGHT DIGITS 1-20)																				
Telephone Number	0484	0485	0486	0487	0488	0489	0490	0491	0492	0493	0494	0495	0496	0497	0498	0499	0500	0501	0502	0503	
(Digits 1-20)																					

CS Receiver 3	ADDRESS 0506-0525 (RIGHT DIGITS 1-20)																				
Telephone Number	0506	0507	0508	0509	0510	0511	0512	0513	0514	0515	0516	0517	0518	0519	0520	0521	0522	0523	0524	0525	
(Digits 1-20)																					

Default for CS Receiver 1 Telephone Number depends on Easy Menu Question "CENTRAL PHONE #".

[Default = blank (*)] across digits 1-20 for CS Receiver Telephone Numbers 2 and 3.

CS RECEIVER TELEPHONE NUMBERS: Enter telephone numbers for any of the three CS Receivers (Telco 1, 2 & 3).

1. Enter digit only.
2. Enter up to 20 digits from left to right. **NOTE:** Leave trailing boxes blank (*). Press [Enter] to save.
3. Valid entries are: 1-9, B = [*] button, C = [#] button, D = 3 sec. pause, E = Wait for dial tone, F = Ignore location

CS SUBSCRIBER ID OPTIONS (ADDRESS 0560-0667)

CS Telco 1 Sub- scriber Opening/ Closing ID Number (Area 1)	ADDRESS 0560-0563 (RIGHT DIGITS 1-4)			
	0560	0561	0562	0563

CS Telco 1 Sub- scriber Event ID Number (Area 1)	ADDRESS 0576-0579 (RIGHT DIGITS 1-4)			
	0576	0577	0578	0579

CS Telco 1 Sub- scriber Event ID Number (System)	ADDRESS 0592-0595 (RIGHT DIGITS 1-4)			
	0592	0593	0594	0595

CS Telco 2 Sub- scriber Opening/ Closing ID Number (Area 1)	ADDRESS 0596-0599 (RIGHT DIGITS 1-4)			
	0596	0597	0598	0599

CS Telco 2 Sub- scriber Event ID Number (Area 1)	ADDRESS 0612-0615 (RIGHT DIGITS 1-4)			
	0612	0613	0614	0615

CS Telco 2 Sub- scriber Event ID Number (System)	ADDRESS 0628-0631 (RIGHT DIGITS 1-4)			
	0628	0629	0630	0631

CS Telco 3 Sub- scriber Opening/ Closing ID Number (Area 1)	ADDRESS 0632-0635 (RIGHT DIGITS 1-4)			
	0632	0633	0634	0635

CS Telco 3 Sub- scriber Event ID Number (Area 1)	ADDRESS 0648-0651 (RIGHT DIGITS 1-4)			
	0648	0649	0650	0651

CS Telco 3 Sub- scriber Event ID Number (System)	ADDRESS 0664-0667 (RIGHT DIGITS 1-4)			
	0664	0665	0666	0667

Default for CS Telco 1 Subscriber Event ID Number (Area 1) depends on Easy Menu Question "ACCOUNT #". [Default = blank (•) blank (•) blank (•) blank (•)] for all other ID Numbers.

CS TELCO SUBSCRIBER ID NUMBERS: Enter the Subscriber Opening/Closing and Event ID Numbers for any of the 3 CS Receivers.

 1. Enter 3 or 4 digits (depending on the CS receiver format) for each subscriber number from left to right.

NOTE: Leave trailing boxes blank (•).

 2. Valid entries are: 1-9, 0 and B-F. **NOTE:** A is not permitted. Press [Enter] to save.

CS SYSTEM REPORTING OPTIONS (ADDRESS 0670-0705)

CS SYSTEM REPORTING CODES	ADDRESS 0670-0682	
	ADDR	
Alarm Restore	blank (*)	0670
Trouble	blank (*)	0671
Trouble Restore	blank (*)	0672
Xmitter Low Battery	blank (*)	0673
Xmitter Supervision	blank (*)	0674
Xmitter Tamper	blank (*)	0675
RESERVED	blank (*)	blank (*)
Opening	blank (*)	0677
Closing	blank (*)	0678
Opening after Alarm	blank (*)	0679
Conditional Close	blank (*)	0680
Cancel	blank (*)	0681
Test Timer		0682

CS SYSTEM REPORTING CODES	ADDRESS 0683-0708	
	ADDR	
Telco Fail	0683	
RF Rec. Trouble	0684	
Memory Fail	0685	
Low Battery	0686	
Panel AC Fail	0687	
EZM Tamper	0688	
Alarm Output Superv.	0689	
Ambush	0698	
Panic	0699	
Fire	0700	
Auxiliary [‡]	0701	
Tamper	0702	
Fail to Open	0703	
Fail to Close	0704	
Keyfob Low Battery	0705	

CS SYSTEM REPORTING CODES:

1. Enter in corresponding address location (left and right digits).
NOTE: Left digit is the first digit and right digit is the second digit in a two digit CS receiver format.
2. Valid entries are: 1-9, 0 and B-F.
NOTE: A is not permitted.
3. To disable a code leave boxes blank (*).
NOTE: Dark shaded data value box shows option not available.
4. Press to save.

[‡]**NOTE:** Keypad Aux. is not to be selected for UL Installations.

[Default = blank (*) blank (*) from address 0670-0682]
[Default = blank (*) blank (*) from address 0683-0705]

CS AREA & SYSTEM REPORTING OPTIONS (ADDRESS 0785, 0786 & 0788)

DISABLE OPENING REPORTS	
ADDRESS 0785	
LEFT DIGIT	RIGHT DIGIT (SUM OF DATA VALUES)
blank (*)	

RIGHT DATA VALUES (CIRCLE)	AREA
1	AREA 1
2	
4	
8	

[Default = blank (*) blank (*)]

DISABLE CLOSING REPORTS	
ADDRESS 0786	
LEFT DIGIT	RIGHT DIGIT (SUM OF DATA VALUES)
blank (*)	

RIGHT DATA VALUES (CIRCLE)	AREA
1	AREA 1
2	
4	
8	

[Default = blank (*) blank (*)]

OPENING REPORT OPTIONS:

1. Select the desired option by circling the data values for each digit (left and right).
2. Add the data values (ex: F=15=(1+2+4+8) from the selected options. See page 13).
3. Enter in address location (left and right digits).

NOTE: Dark shaded data value box shows option not available. Press to save.

0788	CS System Report Options	
Default	Option	
OFF	1	Backup Report on Telco 1 & 2
OFF	2	Touch-tone Dialing Only *
OFF	3	Touch-tone Dialing w/Rotary Backup *
OFF	4	RESERVED
OFF	5	Cancel Next Test Timer on any Report
OFF	6	Disable Wait for Silence (Pager Format)
OFF	7	Disable Wait for Handshake on Transmit
OFF	8	Disable Auto Dial Tone Detect

CS SYSTEM REPORTING OPTIONS:

1. Select the desired option entering the option number (1-8) for each digit.
2. Enter corresponding option number in address location.

NOTE: Dark shaded data value box shows option not available.

3. Press to save.

*** NOTE:** If neither Touch-tone Dialing nor Touch-tone w/Rotary Backup is selected, then system defaults automatically to Rotary Dialing. Leave blank (*) to select Rotary Dialing.

CS ZONE REPORTING OPTIONS (ADDRESS 0720-0735)

ADDRESS 0720-0727							
CONTROL PANEL ZONES REPORT CODE							
ZONE 1	ZONE 2	ZONE 3	ZONE 4	ZONE 5	ZONE 6	ZONE 7	ZONE 8
0720	0721	0722	0723	0724	0725	0726	0727

ADDRESS 0728-0731			
ZONES REPORT CODE			
ZONE 9	ZONE 10	ZONE 11	ZONE 12
0728	0729	0730	0731

ADDRESS 0732-0735			
ZONES REPORT CODE			
ZONE 13	ZONE 14	ZONE 15	ZONE 16
0732	0733	0734	0735

Default for Group Zone Report Codes depends on Easy Menu Question "RCVR. FORMAT".

ZONE REPORT CODE OPTIONS	
DATA ENTRIES	

DATA ENTRIES LEFT	MODEM CODE
1	Fire
2	Panic
3	Burglary
4	Hold up
7	Gas Alarm
8	Heat Alarm
0	Auxiliary Alarm
B	24 Hour Auxiliary

PULSE EVENT CODE will be the first digit of the 2 digit reporting code. The second digit will be the second digit of the reporting zone. For example, for zone 9 (address 0728), if the right digit is "3", then the reporting code is "39". For example, for zone 15 (address 0734), if the right digit is "4", then the reporting code is "45".

MODEM CODES determine the zone types reported for the following formats: SIA and ADEMCO Point ID.

1. Select the desired Modem Code for each zone from the table shown.
2. Press  to save.

CS USER REPORTING OPTIONS (ADDRESS 0800-0831)

Enable Users to Report Opening and Closings	ADDR	USERS 1 → 8								ADDR	USERS 9 → 16							
		U1	U2	U3	U4	U5	U6	U7	U8		U9	U10	U11	U12	U13	U14	U15	U16
		1	2	3	4	5	6	7	8		1	2	3	4	5	6	7	8
Enable Opening Report, Telco 1	0800									0801								
Enable Closing Report, Telco 1	0809									0810								
Enable Opening Report, Telco 3	0818									0819								
Enable Closing Report, Telco 3	0827									0828								

Enable Users to Report Opening and Closings	ADDR	USERS 33 → 36							
		U33	U34	U35	U36				
		1	2	3	4	5	6	7	8
Enable Opening Report, Telco 1	0804								
Enable Closing Report, Telco 1	0813								
Enable Opening Report, Telco 3	0822								
Enable Closing Report, Telco 3	0831								

User 33 = Auto Arming/Disarming
 User 34 = Quickloader Remote Arming/Disarming
 User 35 = Easy Arming (Opening not applicable)
 User 36 = Keyswitch Arming
NOTE: These opening events will report as the user number shown. Also, Keyfobs 1-8 (see Easy Menu Program Driven Mode) will report as Users 9-16, respectively.

CS USER REPORTING OPTIONS: [Default = blank (*) from address 0800-0831]

1. Select the desired option entering the option number (1-8) for each digit.
2. At the keypad, enter corresponding option number in address location. **NOTE:** Dark shaded data value box shows option not available.
3. Press to save.

EZM GROUP OPTIONS (ADDRESS 1455 & 1456)





EZM Group 1	
ADDRESS 1455	

EZM Group 2	
ADDRESS 1456	

EZM TYPE	
DATA ENTRIES	OPTION
blank (*)	Not used (No EZM present)
1	4-Zone EZM

EZM GROUP	ZONES COVERED NORMAL
1	9-12
2	13-16

EZM GROUP OPTIONS: Up to 2 Groups of 4 Zones each may be programmed depending on the number of Zones used and which EZM modules are connected. Each Group represents 4 Zones.

-  1. Select EZM type from the table shown.
-  2. Enter either blank (*) or "1" in corresponding address locations above.
-  3. Press  to save.

AREA BELL CONTROL OPTIONS (ADDRESS 1473, 1477, 1481, 1485)

Output Turns Off upon Disarm

1473 Burglary Output Turns Off upon Disarm		
Default		Option: Disarming:
ON	1	Burg Output Silenced
OFF	2	RESERVED

1477 Pulsed Burg Output Turns Off upon Disarm		
Default		Option: Disarming:
ON	1	Pulsed Burg Output Silenced
OFF	2	RESERVED

Silence PGM1 Output / PGM2 Output

1481 PGM1 Output Turns Off upon Disarm		
Default		Option: Disarming:
ON	1	PGM1 Output Silenced
OFF	2	RESERVED

1485 PGM2 Output Turns Off upon Disarm		
Default		Option: Disarming:
ON	1	PGM2 Burg Output Silenced
OFF	2	RESERVED

OUTPUT TURNS OFF UPON DISARM:

Select options for any of the 4 Outputs. By default, the ability to turn off an output upon disarm is not allowed. Enter digit in address location. **NOTE:** Dark shaded data value box shows option not available. Press  to save.

KEYPAD OPTIONS (ADDRESS 1425-1431, 1440-1446)

Enable Keypad Type & Activation	ADDR	Enable Keypad Type	Keypad Area Assignment
		Blank (*) = Burg Keypad 2 = Wizard † ‡Not for UL Installations	Blank (*) = Disabled 1 = Area 1
Keypad 1	1425		
Keypad 2	1426		
Keypad 3	1427		
Keypad 4	1428		
Keypad 5	1429		
Keypad 6	1430		
Keypad 7	1431		
[Default = blank (*) from address 1425-1431]			



KEYPAD TYPE: Up to 7 keypads may be programmed, if they are connected.

NOTE: See Keypad Configuration Mode.



1. Select keypad type for each keypad from the tables shown.
2. Enter data in corresponding address locations.
3. Press  to save.

Enable Keypad Options	ADDR	Enable Keypad Options							
		Keypad Fire	Keypad Aux. †	Keypad Panic	RSRVD	Ambush	Easy Arming	Panel Access	RSRVD
		1	2	3	4	5	6	7	8
Keypad 1 Options	1440								
Keypad 2 Options	1441								
Keypad 3 Options	1442								
Keypad 4 Options	1443								
Keypad 5 Options	1444								
Keypad 6 Options	1445								
Keypad 7 Options	1446								
[Default = blank (*) from address 1440-1446] † NOTE: Keypad Aux. is not to be selected for UL Installations.									

ENABLE KEYPAD OPTIONS: Select options for any of the 7 keypads.

-  1. Select the desired option entering the option number (1-8) for each digit.
-  2. At the keypad, enter corresponding option number in address location.

NOTE: Dark shaded data value box shows option not available.

-  3. Press  to save.

TEMPERATURE DISPLAY AT KEYPAD (ADDRESS 1666-1668)

--ZONE 6 TEMPERATURE SENSOR--

1666 Temperature Lower Limit [‡]		
Default		Option
OFF	1	Binary Temperature Value 1°
OFF	2	Binary Temperature Value 2°
OFF	3	Binary Temperature Value 4°
OFF	4	Binary Temperature Value 8°
OFF	5	Binary Temperature Value 16°
OFF	6	Binary Temperature Value 32°
OFF	7	Binary Temperature Value 64°
OFF	8	Enable for Negative Temperature Value

1667 Temperature Upper Limit [‡]		
Default		Option
OFF	1	Binary Temperature Value 1°
OFF	2	Binary Temperature Value 2°
OFF	3	Binary Temperature Value 4°
OFF	4	Binary Temperature Value 8°
OFF	5	Binary Temperature Value 16°
OFF	6	Binary Temperature Value 32°
OFF	7	Binary Temperature Value 64°
OFF	8	Enable for Negative Temperature Value

1668 Enable Temperature Options [‡]		
Default		Option
OFF	1	Enable Temperature Display Option
OFF	2	Select Degrees Celsius
OFF	3	Report Temperature Alarm (Zone 6)
OFF	4	Reserved
OFF	5	Reserved
OFF	6	Reserved
OFF	7	Reserved
OFF	8	Reserved

Temperature Display at Keypad

The temperature is displayed instead of the date on line 2 of the GEM-RP1CAe2 (or GEM-K1CA) keypad. The keypad will display from -22F to 140F (or -30C to 60C). Fahrenheit is the default setting, select Celsius by enabling address 1668 option 2. When this Temperature Display Option is enabled, Zone 6 becomes the input for the GEM-TEMP64 Temperature Sensor module and Zone 6 of the panel becomes inoperative.

Address 1668 option 3 enables Zone 6 to report a temperature problem. Address 1666 (options 1-7) set the lower limit temperature value and address 1667 (options 1-7) sets the upper limit temperature value (both values are set in binary). If the temperature detected by the panel is above or below these set limits, the panel will report an alarm on Zone 6. To function and report properly, Zone 6 must be selected as a reporting zone, 24hr zone in area 1 and auto-resettable. At both 1666 and 1667 addresses, option 8 sets positive or negative temperature. If the temperature of 0 degrees is required, "negative zero" (-0) degrees must be used (+0 or an empty location is not a valid temperature). To simulate the sensor module, a power supply can be connected to Zone 6 and set from .55v to 3.05v to display the whole temperature range. Temperature values are read and updated every 5 seconds. To report an outer limit temperature, the temperature must be out of limits for 2 seconds. To avoid false alarm reports, the limits have a threshold of 5 degrees in the software. Two new logs have been created for temperature out of limits and restore. If the  key is depressed and held down for 2 seconds, the date will display for 5 seconds.

In addition, three addresses must be enabled (either via Quickloader or via direct address programming) in order for the **Temperature Display at Keypad** feature to operate.

The following features must be enabled In Quickloader (or in direct address programming):

1. **Keypad Assignment, Temperature Settings** tab, **Enable Temperature Display** (Address 1668, option 1)
2. **Keypad Assignment, Keypad Features** tab, **Enable Keypad Time/Date Display** (Address 1420, option 7)
3. **Keypad Assignment, Keypad Features** tab, **Enable Set Time/Date Message** (Address 2051, option 1)

Note: If these three addresses are set and power (AC and battery) are subsequently removed, they keypad will indicate that the time and date are lost and will need to be reset. See W11425 for more information.

[‡]This feature not evaluated by UL.

ZONE OPTIONS - ZONES 1 TO 16 (ADDRESS 0900-1016)

	ZONE OPTIONS	ADDR	ZONES 1 → 8								ADDR	ZONES 9 → 16							
			Z1	Z2	Z3	Z4	Z5	Z6	Z7	Z8		Z9	Z10	Z11	Z12	Z13	Z14	Z15	Z16
			1	2	3	4	5	6	7	8		1	2	3	4	5	6	7	8
†	50ms Loop Response (A)	0900									0964								
†	Priority	0901									0965								
	Priority with Bypass	0902									0966								
	Auto-Bypass	0903									0967								
†	Selective Bypass	0904									0968								
	Keyswitch Arming	0905									0969								
	Auto-Bypass Re-entry	0906									0970								
	Pre-Alarm Warning	0907									0971								
	Never Arm	0908									0972								
	24-Hour Zone	0909									0973								
†	Alarm Output	0910									0974								
†	Pulsed Alarm Output	0911									0975								
	PGM1 Output	0912									0976								
	PGM2 Output	0913									0977								
†	Entry/Exit 1	0914									0978								
	Entry/Exit 2	0915									0979								
†	Exit/Entry Follower	0916									0980								
†	Auto Reset	0917									0981								
†	Swinger Shutdown	0918									0982								
†	Chime	0919									0983								
	Abort Delay	0920									0984								
	Power-up Delay	0921									0985								
	Day Zone Open	0922									0986								
	Day Zone Short	0923									0987								
	Alarm on Day Zone	0924									0988								
†	Alarm Telco 1	0925									0989								
	Alarm Restore 1	0926									0990								
	Trouble Telco 1	0927									0991								
	Trouble Restore 1	0928									0992								
	Alarm Telco 3	0929									0993								
	Alarm Restore 3	0930									0994								
	Trouble Telco 3	0931									0995								
	Trouble Restore 3	0932									0996								
	No EOL Resistor	0933									0997								
	Trouble on Open	0934									0998								
	Trouble on Short	0935									0999								
†	Zone Area 1	0936									1000								
	RESERVED	0937									1001								
	RESERVED	0938									1002								
	RESERVED	0939									1003								
	Interior (Stay) Bypass	0940									1004								
	Keypad Sounder on Alarm	0941									1005								
†	2-Wire Smoke Detectors (B)	0942									1006								
†	Fire (C)	0943									1007								
	Fire Alarm Verification (C)	0944									1008								
	RESERVED	0945									1009								
	Zone ANDing Group 1	0946									1010								
	Zone ANDing Group 2	0947									1011								
	Zone ANDing Group 3	0948									1012								
	Zone ANDing Group 4	0949									1013								
	Sensor Watch	0950									1014								
	RESERVED	0951									1015								
	Chime 2	0952									1016								
	RESERVED	0953									1017								
	RESERVED	0954									1018								

† When the Easy Program Menu is used, these features are enabled by default.

† Enabled when "Enable SIA CP-01 Features?" is activated (Answer "Yes" in the EZ Programming Menu).

★ Disabled when "Enable SIA CP-01 Features?" is activated (Answer "Yes" in the EZ Programming Menu). Disable Auto-Reset on non-fire zones for SIA CP-01 installations.

ZONE OPTIONS: Select zone options for any zone.

1. Select the desired zone option by entering the option number (1-8) for each selected zone.
2. Enter corresponding option number in address location.

NOTE: Dark shaded data value box shows option not available. Press [Enter] to save.

Notes A, B and C are located on the next page.



NOTES:

- (A) 50ms Loop Response only available for zones 1-8. For all other Zones, loop response is determined by jumpers on the GEM-EZM8 and/or keypad configuration on the GEM-RP1CAe2 or GEM-K1CA.
- (B) 2-wire Smoke Detectors only available for zones 7 & 8, and **Fire** must also be selected.
- (C) If Fire Alarm Verification is selected, then Fire must also be selected.

DEFAULTS: The zone options indicated are automatically set after exiting the Easy Menu Driven Mode.

- *Priority, Selective Bypass, Alarm Output, Auto Reset, Swinger Shutdown* and *Zone Area 1* are enabled for the total number of zones entered in “## OF ZONES IN AREA1 ENTER # ZONES”.
- *Alarm Telco 1* is enabled for the zone number(s) entered in “REPORT ALL ZONES TO CENTRAL ZONES? Y/N”.
- *Entry/Exit 1* and *Chime* are enabled for the zone number(s) entered in “ENTRY/EXIT ZONES ENTER ZONE #”.
- *Exit/Entry Follower* and *Interior Bypass* are enabled for the zone number(s) entered in “INTERIOR ZONES ENTER ZONE #”.
- *Pulse Alarm Output* is enabled for the zone number(s) entered in “FIRE ZONES ENTER ZONE #” or “2-WIRE FIRE ZNS ENTER ZONE #”.
- *Fire* is enabled for the zone number(s) entered in “FIRE ZONES ENTER ZONE #”.
- 2-Wire Smoke Detector is enabled for the zone number(s) entered in “2-WIRE FIRE ZNS ENTER ZONE #”.

THIS PAGE INTENTIONALLY LEFT BLANK



THIS PAGE INTENTIONALLY LEFT BLANK

THIS PAGE INTENTIONALLY LEFT BLANK



THIS PAGE INTENTIONALLY LEFT BLANK

THIS PAGE INTENTIONALLY LEFT BLANK



RF RECEIVER & SUPERVISORY TIMER OPTIONS (ADDRESS 2029-2044 & 2056)

Number of RF Receivers	ADDRESS 2056	
	LEFT DIGIT	RIGHT DIGIT
	blank (*)	

DATA ENTRIES	RF RECEIVER(S)
blank (*)	None
1	1
2	2

RF RECEIVERS: Up to 2 RF Receivers may be programmed.

1. Select the number of receivers from the table shown.
2. Enter number in address location shown.
3. Press  to save.

Default for Number of Receivers depends on Easy Menu Question for RF Transmitters.

RF SUPERVISORY TIMERS: RF Supervisory Timers may be programmed for each type of transmitter used. A transmitter will send a transmission every time it is tripped, when there is NO activity, the transmitter sends a status transmission about once an hour. If the receiver does NOT receive ANY signal (a trip or a status) from a transmitter in the time specified for transmitter type, a system trouble "WIRELESS TROUBLE/EO4-NN SERVICE" will be displayed at the keypad.

1. Select timer delay from the table shown. Timers are programmed in increments of 30 minutes each. Valid entries are [3] through [F] (90 minutes-450 minutes).
2. Enter in corresponding address locations below (right nibble).
3. Press  to save.

RF SUPERVISORY TIMER	RF TRANSMITTER	ADDR	RF SUPERVISORY DELAY TIME (Select timer delay from the table at right)
Type 0	Window/Door, 2 Pt.	2029	
Type 1	Window/Door, 2 Pt.	2030	
Type 2	Window/Door, 2 Pt.	2031	
Type 3	Window/Door, 2 Pt.	2032	
Type 4	RESERVED		
Type 5	PIR	2034	
Type 6	PIR	2035	
Type 7	Smoke Detector	2036	
Type 8	Smoke Detector	2037	
Type 9	RESERVED		
Type A	Dual Tech.	2039	
Type B	RESERVED		
Type C	Window/Door, 4 Pt.	2041	
Type D	PIR	2042	
Type E	Smoke Detector	2043	
Type F	Napco Glass Break	2044	

RF SUPERVISORY TIMERS	
DATA ENTRIES	DELAY
3	90 min.
4	120 min.
5	150 min.
6	180 min.
7	210 min.
8	240 min.
9	270 min.
0	300 min.
B	330 min.
C	360 min.
D	390 min.
E	420 min.
F	450 min.

[Default = blank (*) from address 2029-2044]. Default = 8 (240 minutes)

NOTE: These timers apply only to Supervised RF Transmitters (see RF Transmitters in Easy Menu Driven Mode Programming).

CLEAR PROGRAM OPTIONS (ADDRESS 2285 & 2286)

2285 XX	H
---------	---

Clear Dealer Program (Erases Dealer Program)



This *erases the dealer program*. Use this feature to start a customized default program. Program Data and System Status Memory is erased where Scheduled Data and Zone Descriptions are maintained.

Access address 2285, then press . Data entry is not allowed.

NOTE: Enter Easy Menu Driven Program Mode to program system again.

2286 XX	H
---------	---

Cold Start (Erases Entire Program)



This erases the entire program including Dealer Program by erasing Program Data, Zone Description Data and System Status Data (similar to a new panel).







Access address 2286, then press . Data entry is not allowed.

NOTE: Some features (schedules) can only be programmed again with the Downloading Software. If power fails, time and date restarts at 00:00:00 and a date of 01-01-04 (January 1, 2004).

USER PROGRAM MODE

PRELIMINARY INFORMATION

The User Program Mode is covered in detail in the operating instructions for the keypad in use.

-  The Program Mode cannot be accessed while the communicator is transmitting except during the first three minutes after power-up.
-  After entering codes or data, press the save  button. *Data will not be stored into memory unless this button is pressed.*
-  If the keypad is in the Program Mode and no activity is detected for longer than 4 minutes, a steady tone will sound.
-  Press the  button to silence the sounder and exit the User Program Mode.

NOTE: For ease of programming, it is recommended that a GEM K1CA (or GEM-RP1CAe2) be used. See Keypad Configuration Mode.

If a GEM-RP2ASe2/GEM-K2AS keypad is used, see WI1182.

ACCESSING USER PROGRAM MODE

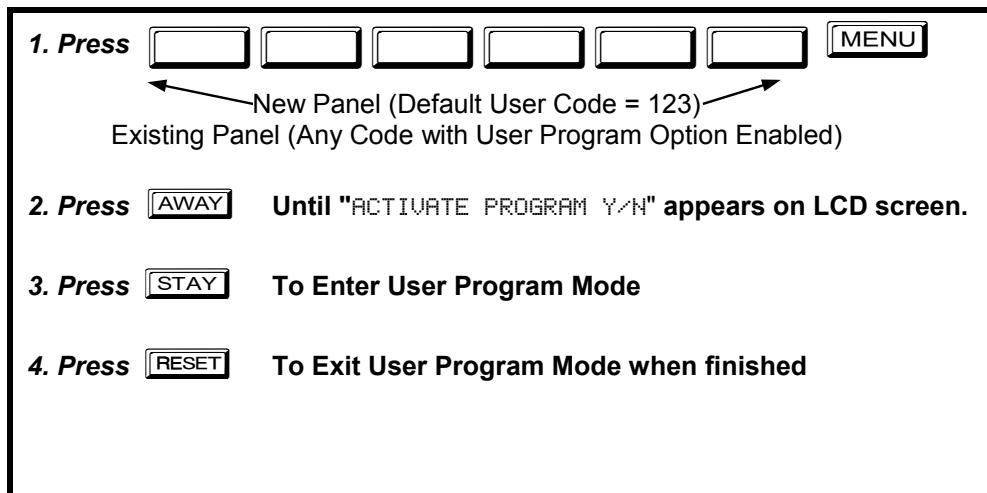

USER CODES

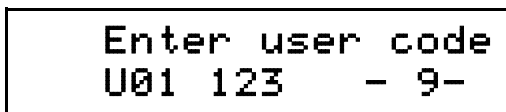

GEM-K1CAe2 Keypad (Direct Entry)

Up to 16 User Codes may be programmed.
NOTE: In this mode, only the code is programmable; the accompanying Area Options must be programmed in the Dealer Program Mode (see page 5).

Use the [MENU] button to place the cursor over the User Number.

Enter a User Number (01–16) using the number buttons. The cursor will then advance to the User Code and read the existing code, if any.

Enter the new User Code using the number buttons (0-9). If an old code is displayed, program over it. To erase the digit at the cursor, press [*] [0] button.

Press the [ENTER] button to save the code in memory.



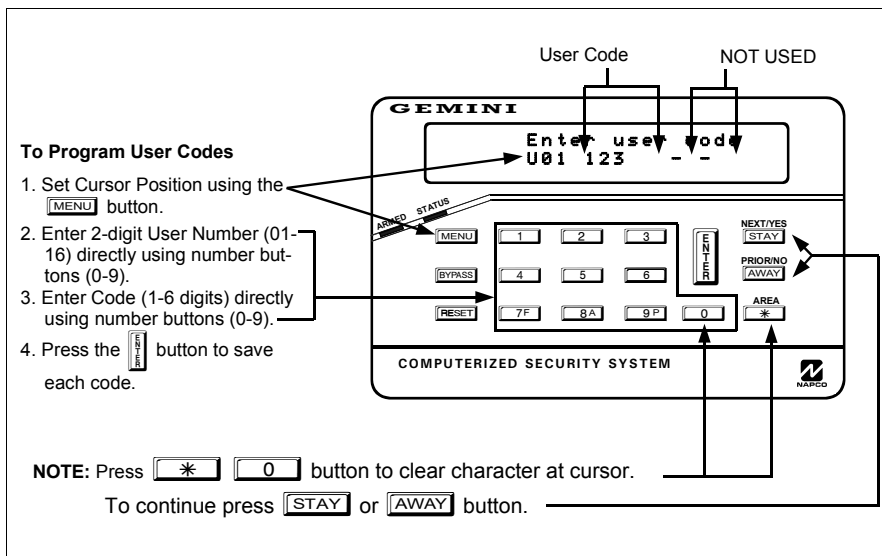

Repeat this procedure for each user. To proceed to Zone-Description programming, press the NEXT/YES button or the PRIOR/NO button.

























Programming User Codes with GEM-K1CA Keypad

ZONE DESCRIPTIONS (GEM-RP1CAE2 / GEM-K1CA KEYPADS)

01-





Enter an identifying description for each zone. Characters are selected by pressing keypad buttons multiple times, "Cell Phone" style. Buttons  through  plus  and  are used, as per the following table:

PRESS:	CHARACTERS DISPLAYED IN SEQUENCE	HOLD  AND PRESS:	CHARACTERS DISPLAYED IN SEQUENCE
	ABC1		abc1
	DEF2		def2
	GHI3		ghi3
	JKL4		jkl4
	MNO5		mno5
	PQR6		pqr6
	STU7		stu7
	VWX8		vwx8
	YZ90		yz90
	(SPACE)•- . () , / : ? #		(Reserved)





Press  to move cursor right.

Press  to move cursor left.

Notes:

- After releasing the number button for 2 seconds, the character will be accepted and the cursor advanced to the right.
- After releasing the number button, if a new number button is pressed before the 2 second window expires, the current character will be accepted and the cursor automatically advanced to the right. The first of the 4 characters of this new number button will be displayed.
- To erase an existing entry, use  or  to move the cursor below the character to be changed. Enter a new character to overwrite the old, or press zero to delete the character.
- To generate lowercase characters, the  button must be pressed and held down while pressing the number button. If the  button is released during the 2 second window, the current character will change to uppercase.

Press  to save.

To advance to the next zone (or to any other zone), move the cursor to the displayed zone number (i.e., "01") using  and . Change the zone number using keys  through . Enter two digits for the zone number (after entering the first digit, the cursor will automatically advance to the second digit). When the second zone number digit is entered, the cursor will automatically advance to the right, allowing the description locations to be entered.

Always press  to save each zone description.

Enter Date

< / / >

(Direct Entry)

Enter Date (Press the  button to set cursor.)

Enter the current date in the format MM/DD/YY, where MM = the month (01–12); DD=the day (01–31); and YY=the year. Press  to save. Press NEXT button to proceed.

Enter Time

< : >

(Direct Entry)

Enter Time (Press the  button to set cursor.)

Enter the current time in the format HH:MMA/P, where HH=hours (01–12); MM=minutes (00–59). Select AM or PM by pressing any number button, then press  once again to save.

NOTE: To enter the date and time, GEM-RP1CAe2/GEM-K1CA keypad (version 9A or greater) must be used and "Enable Keypad Time/Date Display" (Address 1420) must be enabled.

KEYPAD CONFIGURATION MODE

This section will focus on configuring the GEM-RP1CAe2/GEM-K1CA Keypads. If there is more than one keypad in the system, we recommend that either a GEM-RP1CAe2 or a GEM-K1CA keypad be used for programming.

KEYPAD INSTALLATION

Several types of keypads may be used with the GEM-P816: the GEM-RP1CAe2/GEM-K1CA, the GEM-RP2ASe2/GEM-K2AS, the GEM-RP3DGTL/GEM-K3DGTL, and the GEM-RP4RFC/GEM-K4RF series (see WI1182). Each must be assigned an address number (1–7) and each requires its own configuration procedure (see CONFIGURING THE KEYPADS, which follows, and DIRECT ADDRESS KEYPAD AREA OPTIONS). At least 1 keypad must be used; only 1 is required for a single-area Commercial Burglary installation.

GEM-RP1CAe2/GEM-K1CA - is a 2-line combination fire/burglary/access keypad capable of supporting 4 EZM zones and a PGM output. The GEM-RP1CAe2 or GEM-K1CA is recommended for programming. See "Important Note" on page 2 for more information regarding the buttons on the GEM-RP1CAe2/GEM-K1CA keypads.

CONFIGURING THE KEYPADS

A total of up to 7 keypads may be connected to the panel. GEM-RP1CAe2/GEM-K1CA, GEM-RP2ASe2/GEM-K2AS, GEM-RP3DGTL/GEM-K3DGTL, and GEM-RP4RFC/GEM-K4RF series keypads may be intermixed but require different configuration procedures, as described below and in WI1182.

Configuring the GEM-RP1CAe2/GEM-K1CA Keypad

Each GEM-RP1CAe2/GEM-K1CA keypad must be configured for (a) keypad tactile beep; (b) entry sounder; (c) keypad address; (d) compatibility number; (e) EZM address; and (f) zone response.

To enter the Keypad Configuration Mode:

1. Move jumper JP1 (located in the center of the control panel board) from Pins 1-2 (top two) to Pins 2-3 (bottom two). **NOTE:** See Wiring Diagram at the end of this manual.
2. After about 15 seconds, the display will read "XX OUT OF SYSTEM", where XX indicates the keypad address.
3. Press and proceed as follows. (Repeat the following procedure for all keypads).

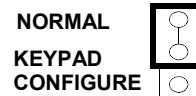

Keypad Tactile Beep

Upon entering the Keypad Configuration Mode, "KEYPAD BEEP ON" will be displayed, indicating that the tactile beep, which sounds when any button is pressed, is on. To turn off the tactile beep, press the button (the button will toggle the tactile beep on and off). Press to continue or press to exit.



Entry Sounder

To turn off the keypad entry sounder during entry time, press (the button will toggle the entry sounder on and off). Press to continue or press to exit.



Keypad Address

If more than one keypad is installed, each must be assigned a unique keypad address (that is, no two keypads may be numbered alike):

Keypads must be numbered consecutively (missing numbers are not permitted)

To assign the keypad number, proceed as follows:

1. Enter the assigned keypad number 01–07, then press to save. A valid number will be acknowledged by a short beep; an invalid number will be rejected by a long beep.
2. Press to continue or press to exit.

<p>New Compat # 0000</p>

Compatibility Number (Not Applicable)

THIS FEATURE IS **NOT** COMPATIBLE WITH THE GEM-P816 CONTROL PANEL. **DO NOT CHANGE THIS SETTING.**

Press the **MENU** button to continue or press the **RESET** button to exit.

<p>EZM Address 01</p>

EZM Address

The keypad's internal EZM (Expansion Zone Module) may be utilized to provide four additional wired zones. Whether used alone or in conjunction with optional GEM-EZM series modules or other keypad EZMs, it must be assigned a unique address (or Group number, see Keypad Programming Workbook) similar to its keypad address. If no other EZMs are to be used,

designate the keypad as Group "01" at the "EZM ADDRESS 00" display. In multiple-EZM systems, enter an assigned group number "01" through "14". (Each EZM must have a unique assigned group number, starting with "01" and proceeding consecutively.) Press the **MENU** button to continue or press the **RESET** button to exit.

<p>Zone Response 00</p>

Zone Response

The normal loop response of each keypad expansion zone is 750mS, however the response time of any zone can be reduced to 50mS as follows.

1. Of the following, circle the number(s) in parentheses associated with the zone(s) to be changed: Zone 1=(1); Zone 2=(2); Zone 3=(4); Zone 4=(8)
2. Add up the circled numbers.

3. At the keypad, enter the sum as a two-digit number "01" through "15" on the display, then press **ENTER**.

Example. Change Zones 2, 3 and 4 to 50mS response.

1. Circle numbers for Zones 2, 3 and 4: (2), (4) and (8).
2. Add up the circled numbers: 2 + 4 + 8 = 14.
3. Enter "14" at the keypad, then press the **ENTER** button.

Press the **MENU** button to continue or press the **RESET** button to exit.

<p>Program Control Message # ?</p>
--

Program Control Message (Not Applicable)

THIS FEATURE IS **NOT** COMPATIBLE WITH THE GEM-P816 CONTROL PANEL.

Press the **MENU** button to continue (the display will loop back through selections, for changes) or press the **RESET** button to exit the Keypad Configuration Mode (display will read "01 OUT OF SYSTEM"). Then replace Jumper JP1 across Pins 1-2 (top two).

EASY MENU PROGRAMMING WORKSHEET - 2 OF 3**RF Transmitter Points:**

XMTR #	ZONE #	RF ID						CHECK SUM	POINT #
		(printed on xmtr box)							
1									
2									
3									
4									
5									
6									
7									
8									
9									
10									
11									
12									
13									
14									
15									
16									

Keyfob Transmitters:

KEYFOB #	Area	RF ID						CHECK SUM	OPTION 1	OPTION 2
		(printed on xmtr box)								
1										
2										
3										
4										
5										
6										
7										
8										

EASY MENU PROGRAMMING WORKSHEET - 3 OF 3

Zone Descriptions 1-16

ZN #	CHARACTERS AVAILABLE (See below)																												
	1	2	3	4	5	6	7	8	9	10	11	12	13	14	15	16	17	18	19	20	21	22	23	24	25	26	27	28	29
1																													
2																													
3																													
4																													
5																													
6																													
7																													
8																													
9																													
10																													
11																													
12																													
13																													
14																													
15																													
16																													

Characters Available for Zone Descriptions
 !@#\$%^&*()_+!|{|}[]`.,.<>?
 1234567890
 abcdefghijklmnopqrstuvwxyz
 ABCDEFGHIJKLMNOPQRSTUVWXYZ

Dealer Code:

NOTES

ALPHABETICAL INDEX

1400HZ HANDSHAKE/KISSOFF, ADDRESS 0461.....	20	AUTO BELL TEST ON ARMING, ADDRESS 1421.....	19
1400HZ HANDSHAKE/KISSOFF, ADDRESS 0483.....	20	AUTO BYPASS RE-ENTRY ZONES.....	7
1400HZ HANDSHAKE/KISSOFF, ADDRESS 0505.....	20	AUTO RESET (ZONE OPTION), ADDRESS 0917, 0981	29
2300HZ HANDSHAKE/KISSOFF, ADDRESS 0461.....	20	AUTO RESET AFTER BURGLARY OUTPUT TIMEOUT, ADDRESS 1421	19
2300HZ HANDSHAKE/KISSOFF, ADDRESS 0483.....	20	AUTO-BYPASS (ZONE OPTION), ADDRESS 0903, 0967	29
2300HZ HANDSHAKE/KISSOFF, ADDRESS 0505.....	20	AUTO-BYPASS RE-ENTRY (ZONE OPTION), ADDRESS 0906, 0970	29
24 HOUR AUXILIARY (MODEM CODE).....	23	AUTOMATIC INTERIOR BYPASS/EASY EXIT, ADDRESS 1424.....	19
24 HOUR ZONES IN AREA 1.....	6	AUX OUTPUT ACTIVATED ON ALARM ZONES	7
24-HOUR ZONE (ZONE OPTION), ADDRESS 0909, 0973	29	AUXILIARY ALARM (MODEM CODE).....	23
2-WIRE FIRE ZONES IN AREA 1	6	AUXILIARY, ADDRESS 0701	22
2-WIRE SMOKE DETECTORS (ZONE OPTION), ADDRESS 0942.....	29	BACKUP REPORT ON TELCO 1 & 2, ADDRESS 0788.....	22
3/1 WITH EXTENDED RESTORES, ADDRESS 0461	20	BINARY (BIT) FORMAT EXAMPLE.....	11
3/1 WITH EXTENDED RESTORES, ADDRESS 0483	20	BIT FORMAT	
3/1 WITH EXTENDED RESTORES, ADDRESS 0505	20	EXAMPLE	11
50MS LOOP RESPONSE (ZONE OPTION), ADDRESS 0900, 0964	29	BURGLARY (MODEM CODE)	23
50MS LOOP RESPONSE ZONES.....	7	BURGLARY OUTPUT TURNS OFF UPON DISARM, ADDRESS 1473	26
ABORT DELAY (ZONE OPTION), ADDRESS 0920, 0984.....	29	BYPASS ENABLE	
ABORT DELAY, ADDRESS 1417.....	15	AREA OPTION	9
AC FAIL REPORT DELAY, ADDRESS 1419.....	15	CALLBACK METHOD.....	4
ACCESS		CALLBACK TELEPHONE NUMBER, ADDRESS 0526-0545	16
AREA OPTION.....	9	CANCEL A CODE	9
ACCESS CONTROL ON PGM2 OUTPUT, ADDRESS 1421.....	19	CANCEL NEXT TEST TIMER ON ANY REPORT, ADDRESS 0788	22
ACCESSING DEALER PROGRAM MODE.....	5	CANCEL, ADDRESS 0681	22
ACTIVATE DOWNLOAD FUNCTION	4	CENTRAL STATION RECEIVER 1 ACCOUNT NUMBER	8
ADDRESS DISPLAYS		CENTRAL STATION RECEIVER 1 FORMAT	8
TYPES.....	11	CENTRAL STATION RECEIVER 1 TELEPHONE NUMBER.....	8
ADDRESS MODE DISPLAYS.....	11	CHANGE PULSE OUTPUT TO TEMPORAL OUTPUT, ADDRESS 1422	19
ADEMCO POINT ID (CS RECEIVER 1 FORMAT)	20	CHANGING OR CANCELING A CODE.....	9
ADEMCO SLOW, SILENT KNIGHT SLOW (CS RECEIVER 1 FORMAT).....	20	CHIME (ZONE OPTION), ADDRESS 0919, 0983.....	29
ALARM ON DAY ZONE (ZONE OPTION), ADDRESS 0924, 0988	29	CHIME 2 (ZONE OPTION), ADDRESS 0952, 1016.....	29
ALARM OUTPUT (ZONE OPTION), ADDRESS 0910, 0974	29	CHIME 2 ZONES IN AREA 1.....	7
ALARM OUTPUT SUPERV., ADDRESS 0689.....	22	CHIME TIME, ADDRESS 1418	15
ALARM OUTPUT TIMEOUT, ADDRESS 1414	16	CHIME ZONES IN AREA 1	7
ALARM OUTPUT, ADDRESS 0836	17	CHIRP OUTPUT ON KEYFOB ARM/DISARM, ADDRESS 1422	19
ALARM OUTPUT, ADDRESS 0857	17	CLEAR DEALER PROGRAM	
ALARM RESTORE 1 (ZONE OPTION), ADDRESS 0926, 0990	29	EASY MENU.....	10
ALARM RESTORE 3 (ZONE OPTION), ADDRESS 0930, 0994	29	CLEAR DEALER PROGRAM, ADDRESS 2285.....	37
ALARM RESTORE, ADDRESS 0670	22	CLOSING REPORT	24
ALARM TELCO 1 (ZONE OPTION), ADDRESS 0925, 0989	29	CLOSING REPORT ONLY ON CONDITIONAL CLOSE, ADDRESS 1420	19
ALARM TELCO 3 (ZONE OPTION), ADDRESS 0929, 0993	29	CLOSING, ADDRESS 0678.....	22
AMBUSH		COLD START	
AREA OPTION.....	9	EASY MENU.....	10
AMBUSH, ADDRESS 0698	22	COLD START, ADDRESS 2286	37
AREA BELL CONTROL OPTIONS (ADDRESS 1473-1485).....	26	COMPATIBILITY NUMBER	41
ARM ONLY		CONDITIONAL CLOSE, ADDRESS 0680	22
AREA OPTION.....	9	CONFIGURING THE KEYPADS.....	40
ARM/DISARM		CONTROL PANEL FIRMWARE VERSION.....	2
AREA OPTION.....	9	CREATE A CUSTOM PROGRAM.....	6

ALPHABETICAL INDEX (CONT'D)

CS AREA & SYSTEM REPORTING OPTIONS (ADDRESS 0785, 0786 & 0788)	22	DISABLE WAIT FOR SILENCE (PAGER FORMAT), ADDRESS 0788	22
CS RECEIVER 1 FORMAT, ADDRESS 0460	20	DISABLE ZONE FAULT SCROLLING, ADDRESS 1420	19
CS RECEIVER 1 TELEPHONE NUMBER, ADDRESS 0462-0481	20	DISABLED	
CS RECEIVER 2 FORMAT, ADDRESS 0482	20	AREA OPTION	9
CS RECEIVER 2 TELEPHONE NUMBER, ADDRESS 0484-0503	20	DON'T CLEAR PGM2 OUTPUT WITH DISARM, ADDRESS 1424	19
CS RECEIVER 3 FORMAT, ADDRESS 0504	20	DOWNLOAD/CALLBACK OPTIONS (ADDRESS 2059 & 0526-0545)	16
CS RECEIVER 3 TELEPHONE NUMBER, ADDRESS 0506-0525	20	DOWNLOADING FROM A COMPUTER	4
CS RECEIVER OPTIONS - TELCO 1, ADDRESS 0461	20	EASY MENU DRIVEN PROGRAM MODE	5
CS RECEIVER OPTIONS - TELCO 2, ADDRESS 0483	20	EASY MENU PROGRAMMING WORKSHEET	42, 43, 44
CS RECEIVER OPTIONS - TELCO 3, ADDRESS 0505	20	EASY MENU-DRIVEN PROGRAM	4
CS SUBSCRIBER ID OPTIONS (ADDRESS 0560-0667)	21	ENABLE "K SERIES" STYLE KEYPADS, ADDRESS 2051	19
CS SYSTEM REPORT OPTIONS, ADDRESS 0788	22	ENABLE ALARM OUTPUT ON TELCO FAIL ONLY WHEN ARMED, ADDRESS 1423	19
CS SYSTEM REPORTING CODES, ADDRESS 0683-0708	22	ENABLE AUTOARM IF NOT CLOSED AT END OF WINDOW, ADDRESS 1420	19
CS TELCO SUBSCRIBER ID NUMBERS	21	ENABLE BURG OUTPUT CHIRP ON KEYFOB	8
CS USER REPORTING OPTIONS (ADDRESS 0800-0831)	24	ENABLE CANCEL REPORT TO TELCO 3, ADDRESS 2051	19
CS ZONE REPORTING OPTIONS (ADDRESS 0720-0735)	23	ENABLE CP-01 EGRESS TONES ONLY, ADDRESS 2053	19
CURRENT TIME	10	ENABLE CP-01 LIMITS, ADDRESS 2053	19
CUSTOM DEFAULT PROGRAM	5	ENABLE GEM-PRINT MODULE, ADDRESS 2051	19
CUSTOMIZING A DEFAULT PROGRAM	5	ENABLE GLOBAL AMBUSH CODE, ADDRESS 1422	19
DATE	10	ENABLE KEYPAD 1 ONLY PROGRAMMING, ADDRESS 2053	19
DAY ZONE OPEN (ZONE OPTION), ADDRESS 0922, 0986	29	ENABLE KEYPAD OPTIONS, ADDRESS 1440-1446	27
DAY ZONE SHORT (ZONE OPTION), ADDRESS 0923, 0987	29	ENABLE KEYPAD SET TIME/DATE MESSAGE, ADDRESS 2051	19
DEALER CODE	10	ENABLE KEYPAD TIME/DATE DISPLAY, ADDRESS 1420	19
DEFAULT	5	ENABLE KEYPAD TYPE & ACTIVATION, ADDRESS 1425-1431	27
DEALER PROGRAM - PRELIMINARY INFORMATION	5	ENABLE LINE-FAULT TEST, ADDRESS 1423	19
DEALER PROGRAM MODE	4	ENABLE LOCAL ALARM ON FIRST ZONE AND TRIP, ADDRESS 1421	19
DEALER PROGRAM MODE		ENABLE MANAGER'S MODE, ADDRESS 1421	19
ACCESSING	5	ENABLE NO EOLR ZONES	7
DECIMAL FORMAT		ENABLE RESIDENTIAL FIRE, ADDRESS 1422	19
EXAMPLE	12	ENABLE SIA CP-01 FEATURES	8
DECIMAL FORMAT EXAMPLE	12	ENABLE TCP/IP AES RPT, ADDRESS 0461	20
DEFAULT DEALER CODE	5	ENABLE TCP/IP AES RPT, ADDRESS 0483	20
DIGITAL DIALER RPT ENTER /EXIT TEST MODE, ADDRESS 2053	19	ENABLE TCP/IP AES RPT, ADDRESS 0505	20
DIRECT ADDRESS OVERVIEW	11	ENABLE TCP/IP COMMUNICATIONS, ADDRESS 2054	19
DIRECT ADDRESS PROGRAM MODE	4	ENABLE TELCO LINE FAULT TEST	7
DIRECT ADDRESS PROGRAM MODE	11	ENABLE TEMPERATURE DISPLAY OPTION, ADDRESS 1668	28
DISABLE [ON/OFF] AS EASY EXIT, ADDRESS 2051	19	ENABLE USERS TO REPORT OPENING AND CLOSINGS	24
DISABLE 2ND CALL ANS. MACHINE OVERRIDE, ADDRESS 1424	19	ENABLE ZONE NUMBER ON PULSE ALARM, ADDRESS 0461	20
DISABLE AUTO DIAL TONE DETECT, ADDRESS 0788	22	ENABLE ZONE NUMBER ON PULSE ALARM, ADDRESS 0483	20
DISABLE CALL WAITING ON 1ST ATTEMPT, ADDRESS 2053	19	ENABLE ZONE NUMBER ON PULSE ALARM, ADDRESS 0505	20
DISABLE CALLBACK DOWNLOAD, ADDRESS 1422	19	ENTER DATE	10, 39
DISABLE CLOSING REPORTS, ADDRESS 0786	22	ENTER TIME	10, 39
DISABLE CODE REQUIRED FOR EZ BYPASS, ADDRESS 1424	19	ENTER USER CODES	8
DISABLE KEYPAD FUNCTION MODE DOWNLOAD, ADDRESS 1422	19	ENTER ZONE DESCRIPTIONS	10
DISABLE KEYPAD INSTANT MODE, ADDRESS 1421	19	ENTRY DELAY 1, ADDRESS 0001	15
DISABLE OPENING REPORTS, ADDRESS 0785	22	ENTRY DELAY 2, ADDRESS 0002	15
DISABLE SYSTEM TROUBLE AUDIBLE TIMEOUT, ADDRESS 2051	19	ENTRY/EXIT 1 (ZONE OPTION), ADDRESS 0914, 0978	29
DISABLE WAIT FOR HANDSHAKE ON TRANSMIT, ADDRESS 0788	22		

ALPHABETICAL INDEX (CONT'D)

ENTRY/EXIT 2 (ZONE OPTION), ADDRESS 0915, 0979	29	KEYPAD INSTALLATION	40
ERASE DEALER PROGRAM, ADDRESS 2285	37	KEYPAD OPTIONS (ADDRESS 1425-1431, 1440-1446)	27
ERASE ENTIRE PROGRAM, ADDRESS 2286	37	KEYPAD SOUNDER ON ALARM (ZONE OPTION), ADDRESS 0941, 1005	29
ERASING DEALER PROGRAM		KEYPAD SOUNDER ON ALARM ZONES	7
EASY MENU	10	KEYPAD TACTILE BEEP	40
ERASING ENTIRE PROGRAM		KEYSWITCH ARMING (ZONE OPTION), ADDRESS 0905, 0969	29
EASY MENU	10	LEADING DIGITS FOR PAGER FORMAT (1ST DIGIT), ADDRESS 0546	16
EXIT DEALER PROGRAM MODE	10	LEADING DIGITS FOR PAGER FORMAT (2ND DIGIT), ADDRESS 0547	16
EXIT DELAY, ADDRESS 0000	15	LINE-FAULT TEST ONLY WHEN ARMED, ADDRESS 1423	19
EXIT TIME RESTART, ADDRESS 2053	19	LOCAL DOWNLOADING	4
EXIT/ENTRY FOLLOWER (ZONE OPTION), ADDRESS 0916, 0980	29	LOCAL OR CENTRAL STATION REPORTING SYSTEM	6
EXIT/ENTRY ZONES IN AREA 1	6	LOW BATTERY, ADDRESS 0686	22
EXIT/ENTRY2 ZONES IN AREA 1	7	LUG E15 AREA 1 ARMED AWAY ONLY, ADDRESS 2052	19
EZM ADDRESS	41	MAINTAINED KEYSWITCH ARMING, ADDRESS 1421	19
EZM GROUP OPTIONS (ADDRESS 1455-1456)	25	MEMORY FAIL, ADDRESS 0685	22
EZM TAMPER, ADDRESS 0688	22	MODEM CODES	23
FAIL TO CLOSE, ADDRESS 0704	22	NEVER ARM (ZONE OPTION), ADDRESS 0908, 0972	29
FAIL TO OPEN, ADDRESS 0703	22	NEW PANELS	5
FIRE (MODEM CODE)	23	NO EOL RESISTOR (ZONE OPTION), ADDRESS 0933, 0997	29
FIRE (ZONE OPTION), ADDRESS 0943, 1007	29	NO. RINGS BEFORE PICKUP, ADDRESS 2059	16
FIRE ALARM VERIFICATION (ZONE OPTION), ADDRESS 0944, 1008	29	NUMBER OF KEYPADS IN AREA 1	8
FIRE ZONES IN AREA 1	6	NUMBER OF RINGS BEFORE PICKUP, ADDRESS 2059	16
FIRE, ADDRESS 0700	22	OPENING AFTER ALARM, ADDRESS 0679	22
FIRMWARE VERSION	2	OPENING REPORT	24
FUNCTION MODE	4	OPENING REPORT ONLY AFTER ALARM REPORT, ADDRESS 1420	19
GAS ALARM (MODEM CODE)	23	OPENING, ADDRESS 0677	22
GEM-P816 WIRING DIAGRAM	56	OUT OF SYSTEM	40
GEM-RP1CAE2/GEM-K1CA KEYPAD EASY PROGRAM MENU	6	PAGER (CS RECEIVER 1 FORMAT)	20
GLOBAL AMBUSH CODE, ADDRESS 2045	17	PAGER FORMAT OPTIONS (ADDRESS 0546 & 0547)	16
HEAT ALARM (MODEM CODE)	23	PANEL AC FAIL, ADDRESS 0687	22
HEXADECIMAL FORMAT		PANIC (MODEM CODE)	23
EXAMPLE	13	PANIC, ADDRESS 0699	22
HEXADECIMAL FORMAT EXAMPLE	13	PGM ON RF TRANSMITTER TAMPER, ADDRESS 2052	19
HOLD UP (MODEM CODE)	23	PGM1 OUTPUT (ZONE OPTION), ADDRESS 0912, 0976	29
INCL. SEL./GRP. BYPASS IN COND. CLOSE /STATUS, ADDRESS 1420	19	PGM1 OUTPUT TIMEOUT, ADDRESS 1416	16
INHIBIT SYSTEM TROUBLE AUDIBLE AT KEYPAD, ADDRESS 1423	19	PGM1 OUTPUT TURNS OFF UPON DISARM, ADDRESS 1481	26
INTERIOR (STAY) BYPASS (ZONE OPTION), ADDRESS 0940, 1004	29	PGM1 OUTPUT, ADDRESS 0838	17
INTERIOR NORMALLY BYPASSED, ADDRESS 1422	19	PGM1 OUTPUT, ADDRESS 0858	17
INTERIOR ZONES IN AREA 1	6	PGM2 OUTPUT (ZONE OPTION), ADDRESS 0913, 0977	29
K SERIES KEYPAD PROGRAMMING	2	PGM2 OUTPUT ACCESS CNTRL TIMEOUT, ADDRESS 1413	15
KEYFOB TRANSMITTERS AS ARM/DISARM & CONTROL DEVICES	9	PGM2 OUTPUT TIMEOUT, ADDRESS 1412	16
KEYFOB TRANSMITTERS AS ZONE INPUT DEVICES	10	PGM2 OUTPUT TURNS OFF UPON DISARM, ADDRESS 1485	26
KEYFOB LOW BATTERY, ADDRESS 0705	22	PGM2 OUTPUT, ADDRESS 0839	17
KEYPAD		PGM2 OUTPUT, ADDRESS 0860	17
CONFIGURING	40	POWER-UP DELAY (ZONE OPTION), ADDRESS 0921, 0985	29
KEYPAD ADDRESS	40	PRE-ALARM WARNING (ZONE OPTION), ADDRESS 0907, 0971	29
KEYPAD CONFIGURATION MODE	40	PRIORITY (ZONE OPTION), ADDRESS 0901, 0965	29
KEYPAD ENTRY SOUNDER	40	PRIORITY WITH BYPASS (ZONE OPTION), ADDRESS 0902, 0966	29

ALPHABETICAL INDEX (CONT'D)

PROGRAM CONTROL MESSAGE.....	41	SWINGER SHUTDOWN (ZONE OPTION), ADDRESS 0918, 0982.....	29
PROGRAMMING CONVENTIONS.....	14	SYSTEM DELAYS & TIMEOUTS (ADDRESS 0000-0002, 1413, 1417, 2050 & 2055).....	15
PROGRAMMING STEPS		SYSTEM DELAYS & TIMEOUTS (ADDRESS 1418-1419).....	15
GENERAL.....	14	SYSTEM OPTIONS (ADDRESS 0836-0863 & 2045).....	17
PROGRAMMING WITH THE K SERIES KEYPADS.....	2	SYSTEM OPTIONS (ADDRESS 1420-1424, 2051-2054).....	19
PULSE ALARM OUTPUT TIMEOUT, ADDRESS 1415.....	16	SYSTEM OUTPUT TIMEOUTS (ADDRESS 1412 & 1414-1416).....	16
PULSE EVENT CODE.....	23	SYSTEM PROGRAMMING OPTIONS.....	4
PULSED ALARM OUTPUT (ZONE OPTION), ADDRESS 0911, 0975.....	29	SYSTEM RESPONSE ACTIVATED BY AREA 1 EVENT/TROUBLE.....	17
PULSED ALARM OUTPUT, ADDRESS 0837.....	17	SYSTEM RESPONSE ACTIVATED BY GLOBAL EVENT/TROUBLE,.....	17
PULSED ALARM OUTPUT, ADDRESS 0856.....	17	TAMPER, ADDRESS 0702.....	22
PULSED BURG OUTPUT TURNS OFF UPON DISARM, ADDRESS 1477.....	26	TCP/IP PANEL/SITE INITIATED FUNCTIONS, ADDRESS 2054.....	19
QUICK METHOD.....	9	TELCO FAIL, ADDRESS 0683.....	22
RADIONICS FAST (CS RECEIVER 1 FORMAT).....	20	TEMPERATURE DISPLAY AT KEYPAD (ADDRESS 1666-1668).....	28
RADIONICS, DCI, FRANKLIN SLOW (CS RECEIVER 1 FORMAT).....	20	TEMPERATURE LOWER LIMIT, ADDRESS 1666.....	28
RELAY MODULE RM3008.....	34	TEMPERATURE OPTIONS, ADDRESS 1668.....	28
REMOTE DOWNLOADING.....	4	TEMPERATURE UPPER LIMIT, ADDRESS 1667.....	28
REPORT CANCEL WINDOW, ADDRESS 2055.....	15	TEST TIMER.....	10
REPORT EVENT TELCO 1, ADDRESS 0840.....	17	TEST TIMER, ADDRESS 0682.....	22
REPORT EVENT TELCO 1, ADDRESS 0861.....	17	TIME.....	10
REPORT EVENT TELCO 3, ADDRESS 0842.....	17	TOTAL NUMBER OF ZONES IN AREA 1.....	6
REPORT EVENT TELCO 3, ADDRESS 0863.....	17	TOUCH-TONE DIALING ONLY, ADDRESS 0788.....	22
REPORT OPENING AND CLOSINGS.....	24	TOUCH-TONE DIALING W/ROTARY BACKUP, ADDRESS 0788.....	22
REPORT RESTORE TELCO 1, ADDRESS 0841.....	17	TRANSMITTER WIRELESS POINTS	
REPORT RESTORE TELCO 3, ADDRESS 0843.....	17	ENROLLING.....	9
REPORT TEMPERATURE ALARM (ZONE 6), ADDRESS 1668.....	28	TROUBLE ON OPEN (ZONE OPTION), ADDRESS 0934, 0998.....	29
RESET DAY ZONE WITH ARM/DISARM ONLY, ADDRESS 1422.....	19	TROUBLE ON SHORT (ZONE OPTION), ADDRESS 0935, 0999.....	29
RESOUND ON WIRELESS SMOKE LOW BATTERY, ADDRESS 1424.....	19	TROUBLE RESTORE 1 (ZONE OPTION), ADDRESS 0928, 0992.....	29
RF REC. TROUBLE, ADDRESS 0684.....	22	TROUBLE RESTORE 3 (ZONE OPTION), ADDRESS 0932, 0996.....	29
RF RECEIVER & SUPERVISORY TIMER OPTIONS (ADDRESS 2029-2044 & 2056).....	36	TROUBLE RESTORE, ADDRESS 0672.....	22
RF TRANSMITTER POINTS.....	9	TROUBLE TELCO 1 (ZONE OPTION), ADDRESS 0927, 0991.....	29
RPT EXIT ERR/RECENT CLOSE, ADDRESS 2053.....	19	TROUBLE TELCO 3 (ZONE OPTION), ADDRESS 0931, 0995.....	29
SELECT ALARM OUTPUT FOR KEYFOB CHIRP, ADDRESS 1423.....	19	TROUBLE, ADDRESS 0671.....	22
SELECT DEGREES CELSIUS, ADDRESS 1668.....	28	UNIVERSAL HIGH SPEED (CS RECEIVER 1 FORMAT).....	20
SELECTIVE BYPASS (ZONE OPTION), ADDRESS 0904, 0968.....	29	USER CODES.....	38
SENSOR WATCH (ZONE OPTION), ADDRESS 0950, 1014.....	29	USER PROGRAM	
SENSOR WATCH TIME, ADDRESS 2050.....	15	AREA OPTION.....	9
SENSOR WATCH ZONES.....	7	USER PROGRAM MODE.....	4
SIA (CS RECEIVER 1 FORMAT).....	20	USER PROGRAM MODE	
SILENT KNIGHT FAST (CS RECEIVER 1 FORMAT).....	20	ACCESSING.....	38
SINGLE DIGIT ONLY, ADDRESS 0461.....	20	PRELIMINARY INFORMATION.....	37
SINGLE DIGIT ONLY, ADDRESS 0483.....	20	USERS TO REPORT OPENING AND CLOSINGS.....	24
SINGLE DIGIT ONLY, ADDRESS 0505.....	20	VERI-PHONE AUDIO PRIORITY OVER ALARMS, ADDRESS 1424.....	19
SOUND ALARM ON EXIT ERROR, ADDRESS 2053.....	19	VERI-PHONE ZONES TRIP PGM2 OUTPUT, ADDRESS 1424.....	19
STATUS REPORT, ADDRESS 1420.....	19	WIRELESS TROUBLE ACTIVATES TELCO 1, ADDRESS 1423.....	19
SUM CHECK, ADDRESS 0461.....	20	WIRELESS TROUBLE ACTIVATES TELCO 3, ADDRESS 1423.....	19
SUM CHECK, ADDRESS 0483.....	20	WIRING DIAGRAM.....	56
SUM CHECK, ADDRESS 0505.....	20	XMITTER LOW BATTERY, ADDRESS 0673.....	22
SUPPRESS BYPASS REMINDER WHEN ARMED, ADDRESS 1421.....	19	XMITTER SUPERVISION, ADDRESS 0674.....	22



ALPHABETICAL INDEX (CONT'D)

XMITTER TAMPER, ADDRESS 0675 22
ZONE 6 TEMPERATURE SENSOR 28
ZONE ANDING GROUP 1 (ZONE OPTION), ADDRESS 0946, 1010 29
ZONE ANDING GROUP 2 (ZONE OPTION), ADDRESS 0947, 1011 29
ZONE ANDING GROUP 3 (ZONE OPTION), ADDRESS 0948, 1012 29
ZONE ANDING GROUP 4 (ZONE OPTION), ADDRESS 0949, 1013 29
ZONE AREA 1 (ZONE OPTION), ADDRESS 0936, 1000 29
ZONE DESCRIPTIONS
 ENTERING 10
ZONE DESCRIPTIONS..... 39
ZONE OPTIONS - ZONES 1 TO 16 (ADDRESS 0900-1016)..... 29
ZONE REPORT CODE OPTIONS 23
ZONE RESPONSE 41

ADDRESS NUMBER INDEX

ADDRESS 0000	EXIT DELAY	15
ADDRESS 0000-0002	SYSTEM DELAYS & TIMEOUTS	15
ADDRESS 0001	ENTRY DELAY 1	15
ADDRESS 0002	ENTRY DELAY 2	15
ADDRESS 0460	CS RECEIVER 1 FORMAT	20
ADDRESS 0461	1400HZ HANDSHAKE/KISSOFF	20
ADDRESS 0461	2300HZ HANDSHAKE/KISSOFF	20
ADDRESS 0461	3/1 WITH EXTENDED RESTORES	20
ADDRESS 0461	CS RECEIVER OPTIONS - TELCO 1	20
ADDRESS 0461	ENABLE ZONE NUMBER ON PULSE ALARM	20
ADDRESS 0461	SINGLE DIGIT ONLY	20
ADDRESS 0461	SUM CHECK	20
ADDRESS 0461	ENABLE TCP/IP AES RPT	20
ADDRESS 0462-0481	CS RECEIVER 1 TELEPHONE NUMBER	20
ADDRESS 0482	CS RECEIVER 2 FORMAT	20
ADDRESS 0483	1400HZ HANDSHAKE/KISSOFF	20
ADDRESS 0483	2300HZ HANDSHAKE/KISSOFF	20
ADDRESS 0483	3/1 WITH EXTENDED RESTORES	20
ADDRESS 0483	CS RECEIVER OPTIONS - TELCO 2	20
ADDRESS 0483	ENABLE ZONE NUMBER ON PULSE ALARM	20
ADDRESS 0483	SINGLE DIGIT ONLY	20
ADDRESS 0483	SUM CHECK	20
ADDRESS 0483	ENABLE TCP/IP AES RPT	20
ADDRESS 0484-0503	CS RECEIVER 2 TELEPHONE NUMBER	20
ADDRESS 0504	CS RECEIVER 3 FORMAT	20
ADDRESS 0505	1400HZ HANDSHAKE/KISSOFF	20
ADDRESS 0505	2300HZ HANDSHAKE/KISSOFF	20
ADDRESS 0505	3/1 WITH EXTENDED RESTORES	20
ADDRESS 0505	CS RECEIVER OPTIONS - TELCO 3	20
ADDRESS 0505	ENABLE ZONE NUMBER ON PULSE ALARM	20
ADDRESS 0505	SINGLE DIGIT ONLY	20
ADDRESS 0505	SUM CHECK	20
ADDRESS 0505	ENABLE TCP/IP AES RPT	20
ADDRESS 0506-0525	CS RECEIVER 3 TELEPHONE NUMBER	20
ADDRESS 0526-0545	DOWNLOAD/CALLBACK OPTIONS	16
ADDRESS 0546	LEADING DIGITS FOR PAGER FORMAT (1ST DIGIT)	16
ADDRESS 0546	PAGER FORMAT OPTIONS	16
ADDRESS 0547	LEADING DIGITS FOR PAGER FORMAT (2ND DIGIT)	16
ADDRESS 0547	PAGER FORMAT OPTIONS	16
ADDRESS 0560-0667	CS SUBSCRIBER ID OPTIONS	21
ADDRESS 0670	ALARM RESTORE	22
ADDRESS 0671	TROUBLE	22
ADDRESS 0672	TROUBLE RESTORE	22
ADDRESS 0673	XMITTER LOW BATTERY	22

ADDRESS NUMBER INDEX (CONT'D)

ADDRESS 0674	XMITTER SUPERVISION	22
ADDRESS 0675	XMITTER TAMPER.....	22
ADDRESS 0677	OPENING	22
ADDRESS 0678	CLOSING.....	22
ADDRESS 0679	OPENING AFTER ALARM.....	22
ADDRESS 0680	CONDITIONAL CLOSE.....	22
ADDRESS 0681	CANCEL	22
ADDRESS 0682	TEST TIMER.....	22
ADDRESS 0683	TELCO FAIL.....	22
ADDRESS 0683-0708	CS SYSTEM REPORTING CODES	22
ADDRESS 0684	RF REC. TROUBLE	22
ADDRESS 0685	MEMORY FAIL	22
ADDRESS 0686	LOW BATTERY	22
ADDRESS 0687	PANEL AC FAIL.....	22
ADDRESS 0688	EZM TAMPER.....	22
ADDRESS 0689	ALARM OUTPUT SUPERV.....	22
ADDRESS 0698	AMBUSH.....	22
ADDRESS 0699	PANIC.....	22
ADDRESS 0700	FIRE.....	22
ADDRESS 0701	AUXILIARY	22
ADDRESS 0702	TAMPER	22
ADDRESS 0703	FAIL TO OPEN	22
ADDRESS 0704	FAIL TO CLOSE	22
ADDRESS 0705	KEYFOB LOW BATTERY	22
ADDRESS 0720-0735	CS ZONE REPORTING OPTIONS	23
ADDRESS 0785	CS AREA & SYSTEM REPORTING OPTIONS.....	22
ADDRESS 0785	DISABLE OPENING REPORTS.....	22
ADDRESS 0786	CS AREA & SYSTEM REPORTING OPTIONS.....	22
ADDRESS 0786	DISABLE CLOSING REPORTS	22
ADDRESS 0788	BACKUP REPORT ON TELCO 1 & 2	22
ADDRESS 0788	CANCEL NEXT TEST TIMER ON ANY REPORT	22
ADDRESS 0788	CS AREA & SYSTEM REPORTING OPTIONS.....	22
ADDRESS 0788	CS SYSTEM REPORT OPTIONS	22
ADDRESS 0788	DISABLE AUTO DIAL TONE DETECT.....	22
ADDRESS 0788	DISABLE WAIT FOR HANDSHAKE ON TRANSMIT.....	22
ADDRESS 0788	DISABLE WAIT FOR SILENCE (PAGER FORMAT)	22
ADDRESS 0788	TOUCH-TONE DIALING ONLY.....	22
ADDRESS 0788	TOUCH-TONE DIALING W/ROTARY BACKUP	22
ADDRESS 0800-0831	CS USER REPORTING OPTIONS	24
ADDRESS 0836	ALARM OUTPUT	17
ADDRESS 0836-0863	SYSTEM OPTIONS	17
ADDRESS 0837	PULSED ALARM OUTPUT	17
ADDRESS 0838	PGM1 OUTPUT	17
ADDRESS 0839	PGM2 OUTPUT	17

ADDRESS NUMBER INDEX (CONT'D)

ADDRESS 0840	REPORT EVENT TELCO 1	17
ADDRESS 0841	REPORT RESTORE TELCO 1	17
ADDRESS 0842	REPORT EVENT TELCO 3	17
ADDRESS 0843	REPORT RESTORE TELCO 3	17
ADDRESS 0856	PULSED ALARM OUTPUT	17
ADDRESS 0857	ALARM OUTPUT	17
ADDRESS 0858	PGM1 OUTPUT	17
ADDRESS 0860	PGM2 OUTPUT	17
ADDRESS 0861	REPORT EVENT TELCO 1	17
ADDRESS 0863	REPORT EVENT TELCO 3	17
ADDRESS 0900-1016	ZONE OPTIONS - ZONES 1 TO 16	29
ADDRESS 1412	PGM2 OUTPUT TIMEOUT	16
ADDRESS 1412	SYSTEM OUTPUT TIMEOUTS	16
ADDRESS 1413	PGM2 OUTPUT ACCESS CNTRL TIMEOUT	15
ADDRESS 1413	SYSTEM DELAYS & TIMEOUTS	15
ADDRESS 1414	ALARM OUTPUT TIMEOUT	16
ADDRESS 1414-1416	SYSTEM OUTPUT TIMEOUTS	16
ADDRESS 1415	PULSE ALARM OUTPUT TIMEOUT	16
ADDRESS 1416	PGM1 OUTPUT TIMEOUT	16
ADDRESS 1417	ABORT DELAY	15
ADDRESS 1417	SYSTEM DELAYS & TIMEOUTS	15
ADDRESS 1418	CHIME TIME	15
ADDRESS 1418-1419	SYSTEM DELAYS & TIMEOUTS	15
ADDRESS 1419	AC FAIL REPORT DELAY	15
ADDRESS 1420	CLOSING REPORT ONLY ON CONDITIONAL CLOSE	19
ADDRESS 1420	DISABLE ZONE FAULT SCROLLING	19
ADDRESS 1420	ENABLE AUTOARM IF NOT CLOSED AT END OF WINDOW	19
ADDRESS 1420	ENABLE KEYPAD TIME/DATE DISPLAY	19
ADDRESS 1420	INCL. SEL./GRP. BYPASS IN COND. CLOSE /STATUS	19
ADDRESS 1420	OPENING REPORT ONLY AFTER ALARM REPORT	19
ADDRESS 1420	STATUS REPORT	19
ADDRESS 1420-1424	SYSTEM OPTIONS	19
ADDRESS 1421	ACCESS CONTROL ON PGM2 OUTPUT	19
ADDRESS 1421	AUTO BELL TEST ON ARMING	19
ADDRESS 1421	AUTO RESET AFTER BURGLARY OUTPUT TIMEOUT	19
ADDRESS 1421	DISABLE KEYPAD INSTANT MODE	19
ADDRESS 1421	ENABLE LOCAL ALARM ON FIRST ZONE AND TRIP	19
ADDRESS 1421	ENABLE MANAGER'S MODE	19
ADDRESS 1421	MAINTAINED KEYSWITCH ARMING	19
ADDRESS 1421	SUPPRESS BYPASS REMINDER WHEN ARMED	19
ADDRESS 1422	CHANGE PULSE OUTPUT TO TEMPORAL OUTPUT	19
ADDRESS 1422	CHIRP OUTPUT ON KEYFOB ARM/DISARM	19
ADDRESS 1422	DISABLE CALLBACK DOWNLOAD	19
ADDRESS 1422	DISABLE KEYPAD FUNCTION MODE DOWNLOAD	19

ADDRESS NUMBER INDEX (CONT'D)

ADDRESS 1422	ENABLE GLOBAL AMBUSH CODE	19
ADDRESS 1422	ENABLE RESIDENTIAL FIRE	19
ADDRESS 1422	INTERIOR NORMALLY BYPASSED	19
ADDRESS 1422	RESET DAY ZONE WITH ARM/DISARM ONLY	19
ADDRESS 1423	ENABLE ALARM OUTPUT ON TELCO FAIL ONLY WHEN ARMED	19
ADDRESS 1423	ENABLE LINE-FAULT TEST	19
ADDRESS 1423	INHIBIT SYSTEM TROUBLE AUDIBLE AT KEYPAD	19
ADDRESS 1423	LINE-FAULT TEST ONLY WHEN ARMED	19
ADDRESS 1423	SELECT ALARM OUTPUT FOR KEYFOB CHIRP	19
ADDRESS 1423	WIRELESS TROUBLE ACTIVATES TELCO 1	19
ADDRESS 1423	WIRELESS TROUBLE ACTIVATES TELCO 3	19
ADDRESS 1424	AUTOMATIC INTERIOR BYPASS/EASY EXIT	19
ADDRESS 1424	DISABLE 2ND CALL ANS. MACHINE OVERRIDE	19
ADDRESS 1424	DISABLE CODE REQUIRED FOR EZ BYPASS	19
ADDRESS 1424	DON'T CLEAR PGM2 OUTPUT WITH DISARM	19
ADDRESS 1424	RESOUND ON WIRELESS SMOKE LOW BATTERY	19
ADDRESS 1424	VERI-PHONE AUDIO PRIORITY OVER ALARMS	19
ADDRESS 1424	VERI-PHONE ZONES TRIP PGM2 OUTPUT	19
ADDRESS 1425-1431	ENABLE KEYPAD TYPE & ACTIVATION	27
ADDRESS 1425-1431	KEYPAD OPTIONS	27
ADDRESS 1440-1446	ENABLE KEYPAD OPTIONS	27
ADDRESS 1440-1446	KEYPAD OPTIONS	27
ADDRESS 1455-1456	EZM GROUP OPTIONS	25
ADDRESS 1473	BURGLARY OUTPUT TURNS OFF UPON DISARM	26
ADDRESS 1473-1485	AREA BELL CONTROL OPTIONS	26
ADDRESS 1477	PULSED BURG OUTPUT TURNS OFF UPON DISARM	26
ADDRESS 1481	PGM1 OUTPUT TURNS OFF UPON DISARM	26
ADDRESS 1485	PGM2 OUTPUT TURNS OFF UPON DISARM	26
ADDRESS 1666	TEMPERATURE LOWER LIMIT	28
ADDRESS 1666-1668	TEMPERATURE DISPLAY AT KEYPAD	28
ADDRESS 1667	TEMPERATURE UPPER LIMIT	28
ADDRESS 1668	ENABLE TEMPERATURE DISPLAY OPTION	28
ADDRESS 1668	REPORT TEMPERATURE ALARM (ZONE 6)	28
ADDRESS 1668	SELECT DEGREES CELSIUS	28
ADDRESS 1668	TEMPERATURE OPTIONS	28
ADDRESS 2029-2044	RF RECEIVER & SUPERVISORY TIMER OPTIONS	36
ADDRESS 2045	GLOBAL AMBUSH CODE	17
ADDRESS 2045	SYSTEM OPTIONS	17
ADDRESS 2050	SENSOR WATCH TIME	15
ADDRESS 2050	SYSTEM DELAYS & TIMEOUTS	15
ADDRESS 2051	DISABLE [ON/OFF] AS EASY EXIT	19
ADDRESS 2051	DISABLE SYSTEM TROUBLE AUDIBLE TIMEOUT	19
ADDRESS 2051	ENABLE "K SERIES" STYLE KEYPADS	19
ADDRESS 2051	ENABLE CANCEL REPORT TO TELCO 3	19

ADDRESS NUMBER INDEX (CONT'D)

ADDRESS 2051	ENABLE GEM-PRINT MODULE	19
ADDRESS 2051	ENABLE KEYPAD SET TIME/DATE MESSAGE	19
ADDRESS 2051-2054	SYSTEM OPTIONS	19
ADDRESS 2052	LUG E15 AREA 1 ARMED AWAY ONLY	19
ADDRESS 2052	PGM ON RF TRANSMITTER TAMPER	19
ADDRESS 2053	DIGITAL DIALER RPT ENTER /EXIT TEST MODE	19
ADDRESS 2053	DISABLE CALL WAITING ON 1ST ATTEMPT	19
ADDRESS 2053	ENABLE CP-01 EGRESS TONES ONLY	19
ADDRESS 2053	ENABLE CP-01 LIMITS	19
ADDRESS 2053	ENABLE KEYPAD 1 ONLY PROGRAMMING	19
ADDRESS 2053	EXIT TIME RESTART	19
ADDRESS 2053	RPT EXIT ERR/RECENT CLOSE	19
ADDRESS 2053	SOUND ALARM ON EXIT ERROR	19
ADDRESS 2054	ENABLE TCP/IP COMMUNICATIONS	19
ADDRESS 2054	TCP/IP PANEL/SITE INITIATED FUNCTIONS	19
ADDRESS 2055	REPORT CANCEL WINDOW	15
ADDRESS 2055	SYSTEM DELAYS & TIMEOUTS	15
ADDRESS 2056	RF RECEIVER & SUPERVISORY TIMER OPTIONS	36
ADDRESS 2059	DOWNLOAD/CALLBACK OPTIONS	16
ADDRESS 2059	NO. RINGS BEFORE PICKUP	16
ADDRESS 2059	NUMBER OF RINGS BEFORE PICKUP	16
ADDRESS 2285	CLEAR DEALER PROGRAM	37
ADDRESS 2285	ERASE DEALER PROGRAM	37
ADDRESS 2286	COLD START	37
ADDRESS 2286	ERASE ENTIRE PROGRAM	37

